

IMPORTANT SAFETY RULES

Please read, understand, and follow all instructions carefully before installing and using this product. Keep for future reference.

PureSpa™ SC-WF20

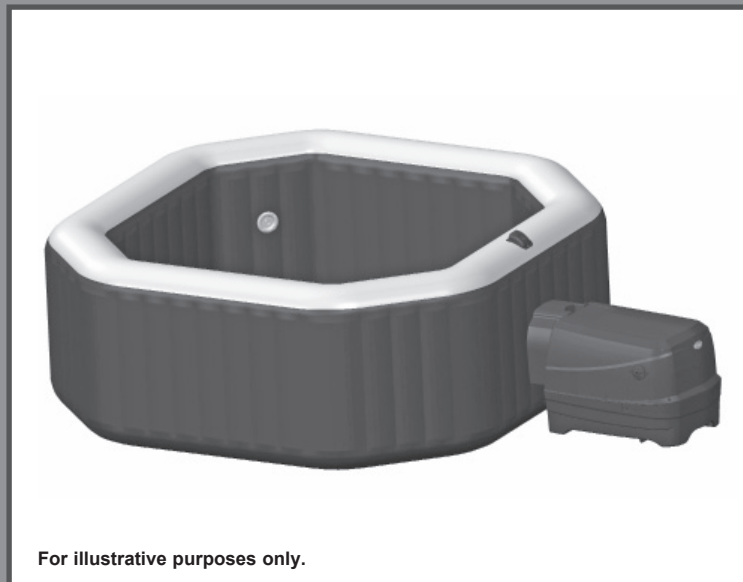

For illustrative purposes only.

Do not forget to try these other fine Intex products: pools, pool accessories, in-home toys, airbeds and boats available at fine retailers or visit our website.

Due to a policy of continuous product improvement, Intex reserves the right to change specifications and appearance, which may result in updates to the instruction manual without notice.

INTEX®

©2024 Intex Marketing Ltd. - Intex Development Co. Ltd. - Intex Recreation Corp. All rights reserved/Tous droits réservés/Todos los derechos reservados/Alle Rechte vorbehalten. Printed in China/Imprimé en Chine/Impreso en China/Gedruckt in China.

®™ Trademarks used in some countries of the world under license from/®™ Marques utilisées dans certains pays sous licence de/Marcas registradas utilizadas en algunos países del mundo bajo licencia de/Warenzeichen verwendet in einigen Ländern der Welt in Lizenz von/Intex Marketing Ltd. to/à/a/an Intex Development Co. Ltd., Hong Kong & Intex Recreation Corp., P.O. Box 1440, Long Beach, CA 90801 • Distributed in the European Union by/Distribué dans l'Union Européenne par/Distribuido en la unión Europea por/Vertrieb in der Europäischen Union durch/Intex Trading B.V., Ettenseweg 46, 4706 PB Roosendaal – The Netherlands • Distributed in the UK by Unitex Service (UK) Limited, 21 Holborn Viaduct, London EC1A 2DY, UK.
www.intexcorp.com

TABLE OF CONTENTS

Warning.....	3-6
Parts.....	7-8
Product Information & Specifications.....	9
Set-up.....	9-14
Salt Level Information.....	15
Operation.....	16-22
LED Code Chart.....	23
Maintenance and Chemicals.....	24-30
Storage.....	30
Troubleshooting.....	31-35
Filter pump motor disassembly.....	36
Warranty.....	37

IMPORTANT SAFETY RULES

When installing and using this electrical equipment, basic safety precautions should always be followed, including the following.

READ AND FOLLOW ALL INSTRUCTIONS

DANGER

- Risk of Accidental Drowning (especially children under 5 years). Caution shall be exercised to prevent unauthorized access to spa by children. This can be reached by adult supervisor securing the means of access or installing a safety protection device to the spa. To avoid accidents during spa use, ensure that children are kept under constant supervision.
- Risk of drowning. Inspect the spa cover regularly for leaks, premature wear and tear, damage, or signs of deterioration. Never use a worn or damaged cover: it will not provide the level of protection required to prevent unsupervised access to the spa by a child.
- Risk of injury. The suction fittings in this spa are sized to match the specific water flow created by the pump. Should the need arise to replace the suction fittings or the pump, be sure that the flow rates are compatible. Never operate spa if the suction fittings are broken or missing. Never replace a suction fitting with one rated less than the flow rate marked on the original suction fitting.
- Risk of injury. Replace damaged cord immediately. Do not bury cord. Never use an extension cord.
- Risk of Electric Shock. Do not permit any electric appliance, such as a light, telephone, radio, or television, within 3.5 m (11.5 feet) of a spa or hot tub.
- Risk of Electric Shock. Do not use and unplug the spa when it is raining, thundering or lightning.

WARNING

- The spa electrical appliance should be supplied through a residual current device (RCD) having a rated residual operating current not exceeding 30 mA.
- The spa electrical appliance comprises a portable residual current device (PRCD) having a rated residual operating current not exceeding 10 mA. If a leakage current of more than 10 mA is detected, the PRCD will operate and cut-off the power supply, in such case, unplug and stop using the spa at once. You must contact the local service center for assistance and/or repair of the product.
- Parts containing live parts, except parts supplied with safety extra-low voltage not exceeding 12V, must be inaccessible to a person in the spa.
- Electrical installation shall fulfill the requirements of local national standards.
- Parts incorporating electrical components, except remote control devices, must be located or fixed so that they cannot fall into the spa.
- To reduce the risk of injury, do not permit children to use this product unless they are closely supervised at all times.
- Children should not use spas or hot tubs without adult supervision.
- To reduce the risk of child drowning, supervise children at all times. Attach and lock spa cover after each use.
- To reduce the risk of injury/illness:
 - a) The water in a spa should never exceed 40°C (104°F). Water temperatures between 38°C (100°F) and 40°C (104°F) are considered safe for a healthy adult. Lower water temperatures are recommended for young children and when spa use exceeds 10 minutes. It is recommended to seek medical advice before use.
 - b) Since excessive water temperatures have a high potential for causing fetal damage during the early months of pregnancy, pregnant or possibly pregnant women should limit spa water temperature and duration of use and should also seek medical advice.

WARNING

- c) The user should check the water temperature before entering the spa.
- d) The use of alcohol, drugs, or medication before or during spa use may lead to unconsciousness with the possibility of drowning.
- e) Persons with any medical condition should seek medical advice before using a spa.
- f) Persons using medication and/or having an adverse medical history should seek medical advice before using a spa since some medication may induce drowsiness while other medication may affect heart rate, blood pressure, and circulation.
- g) Avoid putting the head underwater and swallowing spa water.
 - People with infectious diseases should not use a spa or hot tub.
 - To avoid injury exercise care when entering or existing the spa or hot tub.
 - Pregnant and possible pregnant women should consult a physician before using a spa or hot tub.
 - Water temperature in excess of 38°C degree may be injurious to your health.
 - Do not use a spa or hot tub immediately following strenuous exercise.
 - Prolonged immersion in a spa or hot tub may be injurious to your health.
 - When pregnant, soaking in hot water for long periods can harm your fetus. Measure the water temperature before entering. Do not enter spa if water is hotter than 38°C (100°F). Do not stay in spa for longer than 10 minutes.
 - Spa heat in conjunction with alcohol, drugs, or medication can cause unconsciousness.
 - Exit immediately if uncomfortable, dizzy, or sleepy. Spa heat can cause hyperthermia and unconsciousness.
 - The causes, symptoms, and effects of hyperthermia may be described as follows: Hyperthermia occurs when the internal temperature of the body reaches a level several degrees above the normal body temperature of 37°C (98.6°F). The symptoms of hyperthermia include an increase in the internal temperature of the body, dizziness, lethargy, drowsiness, and fainting. The effects of hyperthermia include failure to perceive heat; failure to recognize the need to exit spa or hot tub; unawareness of impending hazard; fetal damage in pregnant women; physical inability to exit the spa or hot tub; and unconsciousness resulting in the danger of drowning.
 - The use of alcohol, drugs, or medication can greatly increase the risk of fatal hyperthermia in hot tubs and spas.
 - Always add chemicals to water, never add water to chemicals. Adding water to chemicals may cause strong fumes or violent reactions and hazardous chemical spray.
 - Never jump or dive into a spa or any shallow body of water.
 - Assembly and disassembly by adults only.
 - This appliance can be used by children aged from 8 years and above and persons with reduced physical, sensory or mental capabilities or lack of experience and knowledge if they have been given supervision or instruction concerning use of the appliance in a safe way and understand the hazards involved. Children shall not play with the appliance. Cleaning and user maintenance shall not be made by children without supervision.
 - No part of the electrical appliance is to be located above the bath during use.
 - Keep the plug of this product more than 4m away from the spa and at a height of 1.2m at least.
 - Always unplug this product from the electrical outlet before removing, cleaning, servicing or making any adjustment to the product, and on raining days.
 - Do not bury the electrical cord. Locate the cord where it will not be damaged by lawn mowers, hedge trimmers and other equipment.

⚠ WARNING

- If the supply cord is damaged, it must be replaced by the manufacturer, its service agent or similarly qualified persons in order to avoid a hazard. Use only identical replacement parts when servicing.
- **Always keep plug dry, plug in with wet plug is definitely forbidden!**
- The plug of SPA must be directly connected only to a earthed socket-outlet from a fixed electrical installation.
- To reduce the risk of electric shock and fire, do not use extension cords, timers, plug adaptors or converter plugs to connect unit to electrical supply; provide a properly located outlet.
- Do not attempt to plug in or unplug this product while standing in water or when your hands are wet.
- Do not leave the spa empty for extended period of time. Do not expose the spa to direct sunlight for extended period of time.
- When the appliance is not in use for long period of time, such as in the winter, the spa set should be disassembled and stored indoor.
- Do not allow the water in the spa to freeze. Do not turn on the spa when the water is frozen.
- Do not use the spa if damaged in delivery and/or malfunctioning in any fashion. Contact the Intex service center for further direction.
- Never use the spa alone or allow others to use the spa alone.
- Never pour water with a temperature higher than 40°C (104°F) into the spa directly.
- Keep all pets away from spa to avoid any damage.
- Do not add bath oil or bath salt to the spa water.
- The spa must be setup on a level, flat and smooth surface that is capable of supporting the maximum load of the filled spa with four adult occupants: weight 2500 lbs (1136 kg); six adults: 3500 lbs (1592 kg).
- Provide adequate drainage system around the spa to deal with overflow water and splashes.
- Use accessories exclusively provided by the spa manufacturer for safety reasons.
- Not for public/commercial use and/or domestic renting dwelling settings.
- All the information pertaining to the installation, cleaning and maintenance please refer to below paragraphs of the manual.
- Never place any metallic objects on the surface of the control base charging dock.

Carefully read, understand, and follow all information in this user manual before installing and using the spa. These warnings, instructions, and safety guidelines address some common risks of water recreation, but they cannot cover all risks and dangers in all cases. Always use caution, common sense, and good judgment when enjoying any water activity. Retain this information for future use.

Non swimmers safety

- Continuous, active, and vigilant supervision of weak swimmers and non-swimmers especially in exercise spas, by a competent adult is required at all times (remembering that children under five are at the highest risk of drowning).
- Designate a competent adult to supervise the spa each time it is being used.
- When the spa is not in use, or unsupervised, remove all toys from the spa and its surrounding area to avoid attracting children to the spa.

Safety devices

- A safety cover or other safety protection device shall be used, or all doors and windows (where applicable) shall be secured to prevent unauthorized access to the spa.

⚠ WARNING

- Barriers, covers, alarms, or similar safety devices are helpful aids, but they are not substitutes for continuous and competent adult supervision.

Safety equipment

- Keep a working phone and a list of emergency phone numbers near the spa.

Safe use of the spa

- Encourage all users especially children to learn how to swim.
- Learn Basic Life Support (Cardiopulmonary Resuscitation - CPR) and refresh this knowledge regularly. This can make a life-saving difference in the event of an emergency.
- Instruct all spa users, including children, what to do in case of an emergency.
- Never dive into any shallow body of water. This can lead to serious injury or death.
- Do not use the spa when using alcohol or medication that may impair your ability to safely use the spa.
- When covers are used, remove them completely from the water surface before entering the spa.
- Protect spa occupants from water related illnesses by advising them to keep water treated and practicing good hygiene. Consult the water treatment guidelines in the user's manual.
- Store chemicals out of the reach of children.
- Attached the safety signage provided on the spa or within 2 m of the spa in a prominent visible position.
- This device contains batteries which cannot be replaced.

⚠ WARNING

- This product is provided with a RCD located at the end of the power cord. The RCD must be tested before each use. Do not use the spa if the RCD does not function properly. Disconnect the power cord until the fault has been identified and corrected. Contact a qualified electrician to correct the fault. Do not bypass the RCD. There are no serviceable parts inside the RCD. Opening the RCD will void the warranty.

1. Plug the unit into a grounded electrical outlet.
2. Press the **RESET** button on the RCD.
3. Turn on the spa electrical equipment.
4. Press the **TEST** button on the RCD. The RCD indicator should turn off and the electrical equipment should shut off. If the RCD indicator does not turn off, and the electrical equipment does not shut off, the RCD is faulty. Do not use the spa. Contact a qualified electrician to correct the fault.
5. Press the **RESET** button on the RCD. The indicator on the RCD should turn on. If the RCD indicator does not turn on, the RCD is faulty. Do not use the spa. Contact a qualified electrician immediately to correct the fault.

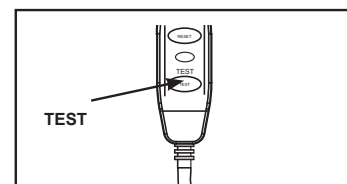
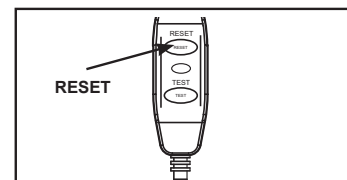

⚠ CAUTION

- In order to avoid a hazard due to inadvertent resetting of the thermal cut-out, this appliance must not be supplied through an external switching device, such as a timer, or connected to a circuit that is regularly switched on and off by the utility.
- Maintain water chemistry in accordance with manufacturer's instructions.

PARTS

Before assembling your product, please take a few minutes to check the contents and become familiar with all the parts.

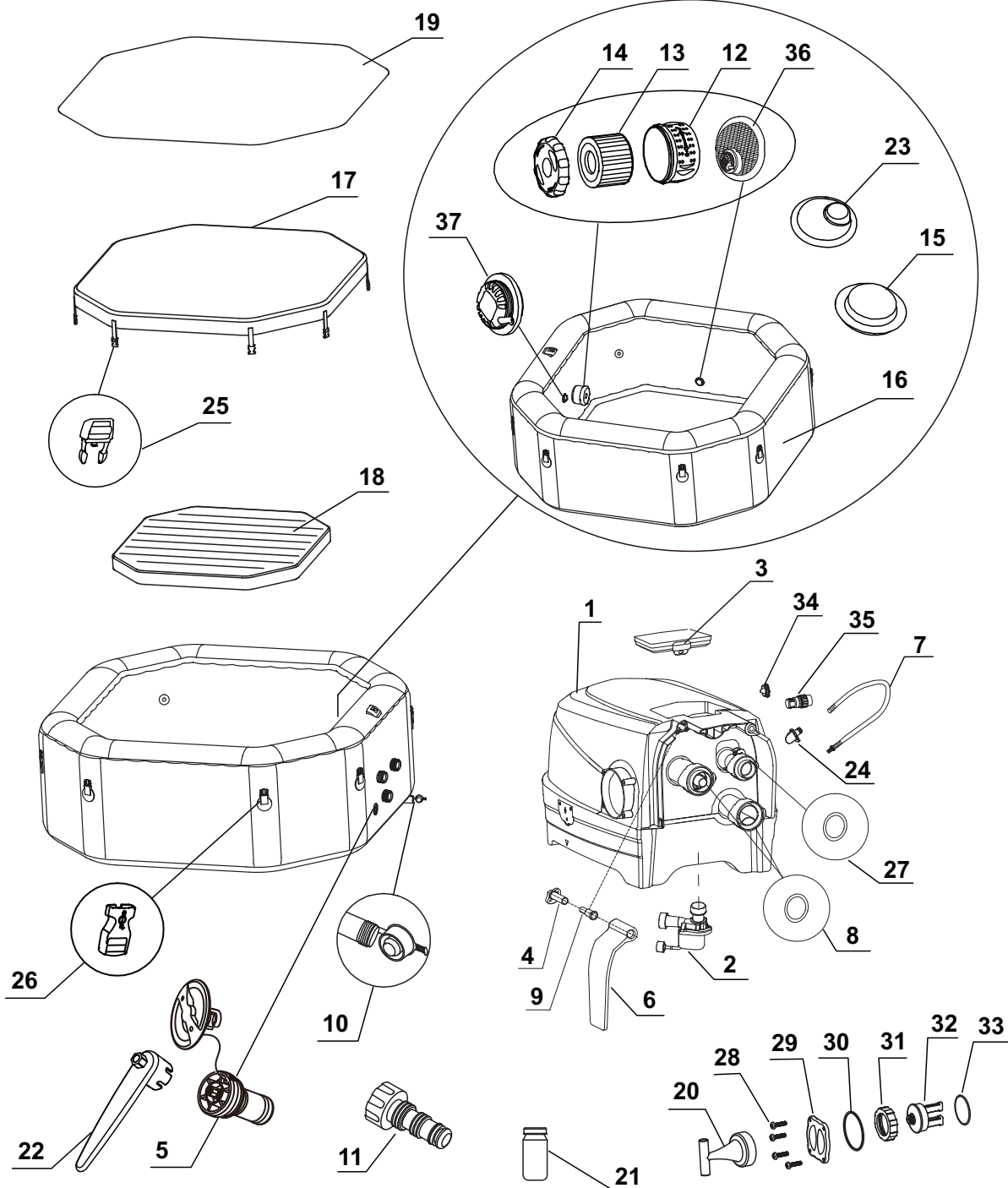

NOTE: Drawings for illustration purpose only. Actual product may vary. Not to scale.

PARTS (continued)

Before assembling your product, please take a few minutes to check the contents and become familiar with all the parts.

REF. NO.	DESCRIPTION	QTY.	SPARE PART NO.	
			4 ADULTS	6 ADULTS
1	CONTROL BASE	1	13028	13028
2	SPA FILTER MOTOR	1	12778	12778
3	CONTROL PANEL	1	12966	12966
4	SIDE COVER HINGE BASE	2	12771	12771
5	AIR PRESSURE RELEASE VALVE CORE	1	12589A	12589A
6	CONTROL BASE SIDE COVER	2	12770	12770
7	SPA INFLATION HOSE	1	11830	11830
8	SPA CONTROL INLET/OUTLET O-RING	2	11788	11788
9	SIDE COVER HINGE FIXER	2	12772	12772
10	SPA DRAIN PLUG	1	13076	13076
11	SPA DRAIN VALVE ADAPTOR	1	13036	13036
12	FILTER CARTRIDGE HOUSING	1	11798	11798
13	FILTER CARTRIDGE	2	11692	11692
14	FILTER CARTRIDGE HOUSING LID	1	11797	11797
15	INLET PLUG	1	11739	11739
16	SPA TUB	1	12724A	12746A
17	SPA COVER	1	11951	12117
18	SPA COVER INFLATABLE BLADDER (PRE-INSTALLED IN SPA COVER)	1	11884	12114
19	GROUND CLOTH	1	11933	12110
20	ELECTROLYTIC CELL NUT WRENCH	1	11854	11854
21	TEST STRIPS	1	11855	11855
22	WRENCH	1	11742A	11742A
23	OUTLET PLUG	2	11782	11782
24	HOSE ADAPTOR	1	12773	12773
25	MALE BUCKLE	8	11994	11994
26	FEMALE BUCKLE	8	11993	11993
27	SPA CONTROL AIR INLET O-RING	1	11687	11687
28	ELECTROLYTIC CELL COVER SCREW	4	11712	11712
29	ELECTROLYTIC CELL COVER	1	11890	11890
30	ELECTROLYTIC CELL COVER O-RING	1	11897	11897
31	ELECTROLYTIC CELL NUT	1	11852	11852
32	ELECTROLYTIC CELL	1	11851	11851
33	ELECTROLYTIC CELL O-RING	1	11853	11853
34	DEFLATION OUTLET CAP	1	12775	12775
35	DEFLATION HOSE ADAPTOR	1	12774	12774
36	OUTLET SUCTION FITTING	1	11785	11785
37	INLET SUCTION FITTING	1	12702	12702

When ordering parts, be sure to quote the model number and part numbers.

PRODUCT SPECIFICATIONS

Maximum seating capacity:	4 adults	6 adults
Voltage / Frequency / Phase	220 – 240 V / 50 Hz / 1 PH	
Water capacity:	210 gal (795 L)	290 gal (1098 L)
Inner/outer size:	51/71 in (130/180 cm)	63/83 in (160/211 cm)
Height:	28 in (71 cm)	
Jet pump:	1000 Watts	
Bubble air blower:	800 Watts	
Filter pump flow rate:	460 gal/hr (1,741 L/hr)	
Heater power:	2,200 Watts	
Temperature range:	10°C – 40°C (50°F – 104°F)	
Temperature rise:	1.5-2.5°C/hr (3°F – 4.5°F/hr)	1-2°C/hr (2°F – 3.5°F/hr)
Number of Water Jet Nozzles:	4	6
Number of Bubble Jets:	120	140
Spa tub recommended working air pressure:	0.083 bar (1.2 psi)	

RF frequency band: 2408~2476MHz

Transmitter power: 10dBm

Wifi frequency band: 2412~2484MHz

Maximum transmitter power: 100mW

Radio frequency radiation exposure Information:

This equipment complies with the radiation exposure limits set forth for an uncontrolled environment. This equipment should be installed and operated with minimum distance of 20 cm (7.9") between the radiator and your body. This transmitter must not be co-located or operating in conjunction with any other antenna or transmitter. Inflatable, portable aboveground cord-connected spa with pump, heater, water jet, blower, control panel, built-in hard water treatment, and sanitation system.

Note: the spa equipment features a complete grounding system that is also in contact with the spa water. It is possible that a person may build up static electricity that discharges when touching the water. Regardless, any electric shock experienced should be investigated by a qualified electrician prior to use of the spa. Unplug the spa until the cause is determined and any corrective action completed.

Hereby, Intex Development Company Limited, declares that this SC-WF20 is in compliance with the essential requirements and other relevant provisions of Directive 2014/53/EU.

⚠ WARNING

Risk of fire: This product draws a minimum of 13 AMPS. Most household circuits are 13 to 16 AMPS. If the circuit breaker trips, please check that no other appliances or other large loads are on the same circuit as the spa. Never use an extension cord. Unfold the line cord prior to use. Never place the plug on combustible materials.

SET UP

Site preparation and requirements

- The spa can be installed indoor or outdoor. For household use only.
- Make sure the area is water resistant, level, flat and free of sharp objects under or around the spa.
- Provide a properly located grounded electrical outlet with a protection grade of IPX4 or higher to connect the spa and allow easy access for periodic testing of the cord mounted RCD.
- Make sure there is enough clearance around the spa for full access to the spa equipment for maintenance and/or service.
- The area shall facilitate draining purposes during long term spa storage. Check local and national regulations regarding spa water disposal requirements.
- To reduce noise disturbance, do not install the spa in the immediate vicinity of vertical walls.
- The area shall be within reach of fresh water supply in compliance with local water regulations, and whose parameters shall be adjusted according to the spa water chemistry and balance section of the manual before first use of the spa.
- Check your local laws and regulations regarding indoor and/or outdoor spa installation.

NOTE: Before setting up and filling the spa with water, make sure the area where the spa will be installed is within your WiFi router coverage range. The area shall be free from metallic walls/mesh and other objects that may interfere with or reduce the WiFi signal.

SET UP (continued)

Additional requirements for indoor installation

- Make sure the floor can support the full weight of the filled spa with the maximum number of occupants. Check with a qualified contractor or a structural engineer to verify this requirement.
- Make sure the floor is water resistant and non-slip surface. Do not install the spa on carpet or other materials that will be damaged by moisture, condensation.
- Do not install the spa indoors on a second floor above finished living space due to the possibility of water and humidity damage.
- Humidity is a natural side effect of indoor spa installation. The room shall be properly ventilated to allow moisture to escape. Install a ventilating system to prevent excess condensation, moisture in the room.
- Have consideration when removing the spa from the chamber/building without destroying part of the built structure. Where non-porous duckboard type flooring is used, make sure it is equipped with a drainage system underneath to allow cleaning and easier removal. When spa is located indoors, watch out for areas that have high water tables as they are prone to flooding.

Additional requirements for outdoor installation

- Spa owners may need to comply with local or states laws relating to childproof fencing, safety barriers, lighting, and other safety requirements. Contact your local building code enforcement office for further details.
- Make sure the surface is level, flat, smooth and strong enough to support the full weight of the filled spa.
- Do not setup the spa on grass or dirt, as this increases the amount of debris entering the spa, and damage the spa floor.
- **Do not expose the spa to direct sunlight for extended period of time. Provide protection from the sun such as sunshade, tent, awning or gazebo.**
- It is possible to install and leave the spa outside at a temperature not lower than 4°C (39°F) provided the water temperature inside the spa is higher than 4°C (39°F) and the water inside the circulation system, pump, pipe are not frozen. Put a "temp barrier mat" between the spa floor and the ground to prevent heat loss from the bottom of the spa and to provide better heat retention. Do not use the spa if the ambient or water temperature is 4°C (39°F) or lower.
- Pay attention to local environmental conditions, such as ground water and risk of frost when install the spa. Professional installer shall have a discussion of these conditions with the client.

Setup the spa with at least 2 persons.

1. Move the entire package to the selected site. Do not drag the spa tub across the ground as this can cause damage and leakage.
Open the carton carefully as this carton can be used to store the spa during long term storage or when not in use.
2. Lay out all the parts on the ground and make sure all the parts are accounted for. For missing or damaged parts contact the appropriate Intex Service Center listed in the separate "Authorized service Centers" sheet.

Spa Control Panel Charging and Installation

1. Make sure the back of the control panel (3) and the control base charging dock surface are clean and dry.
2. Make sure the control base is plugged in and the RCD tested. Place the control panel (3) on the control base charging dock to charge the built-in battery (see drawing 1). See "Spa Control Panel" operation section for more details.
3. It takes approximately 3 hours to fully charge the control panel battery. Once the battery is fully charged, you may place the control panel on top of the spa tub wall (see drawing 2.1). To remove the control panel from the spa tub, lift the latch while pulling the control panel away from the support stand (see drawing 2.2).

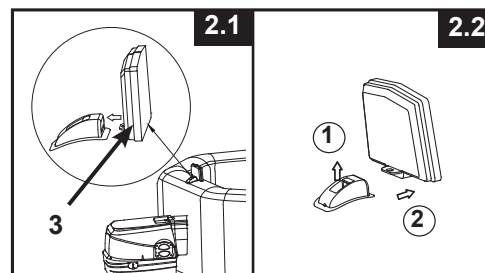
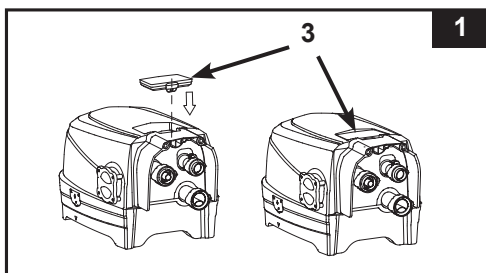

SET UP (continued)

Optional equipotential bonding system

Depending on local building codes and regulations, have a qualified electrician to connect the spa equipotential terminal with a conductor (wire) having a nominal cross-sectional area of 2.5 mm² to 6mm² to the household equipotential terminal. (Wire not included)

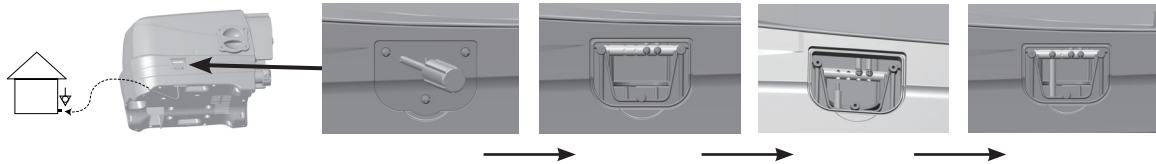

Inflation

Inflate the Spa Tub Wall

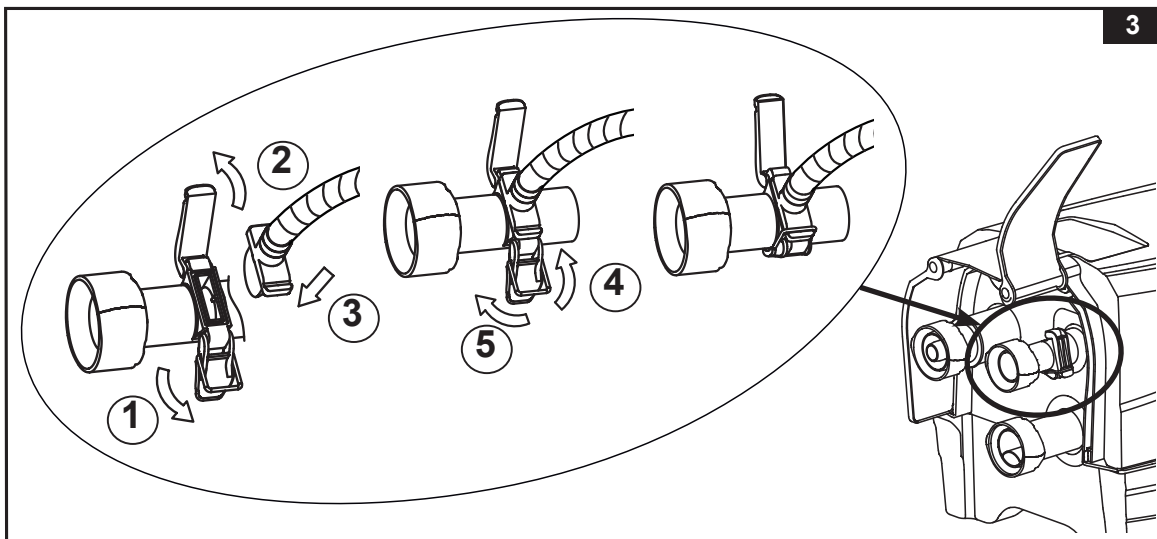

1. Take out the ground cloth (19) and spread it over the cleared area. Then spread out the spa liner over the ground cloth and point the drain valve towards a suitable draining area.
NOTE: Spread the ground cloth with the bubbles facing down over the cleared area where you intend to setup your spa.
2. Flip up the control base side cover (36) to reveal the air blower inflation outlet. Pull out the latch to open the cover, insert the hose adaptor (24) with hose and reattach the latch to the hose adaptor to secure it in place (see drawing 3).



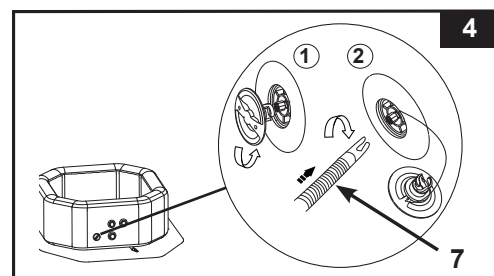

3. Unscrew the air valve cap on the spa tub to reveal the stem in the up position for inflation. Insert the other end of the inflation hose (7) into the valve and turn to the right to lock it in position (see drawing 4).

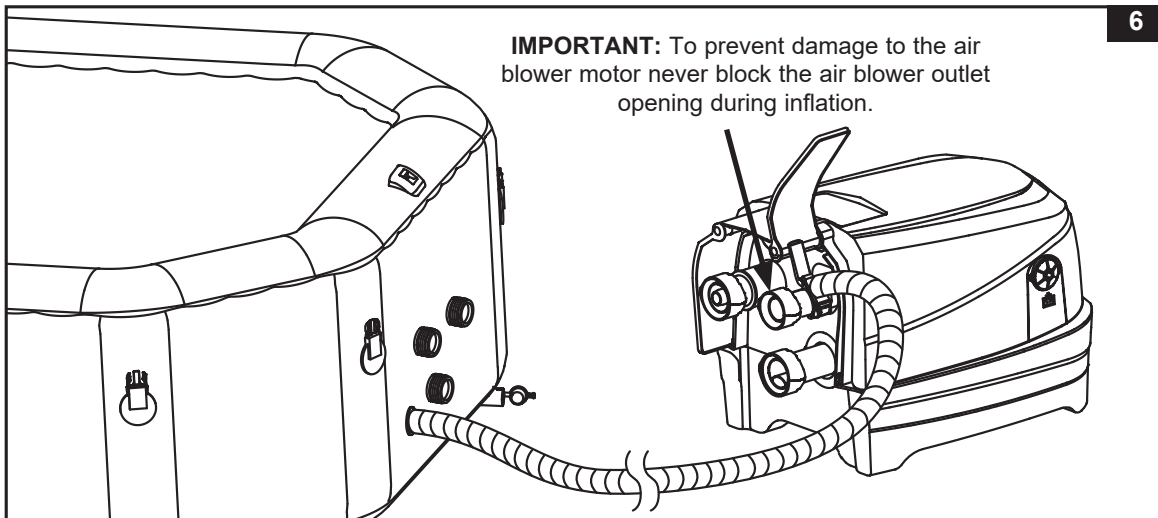
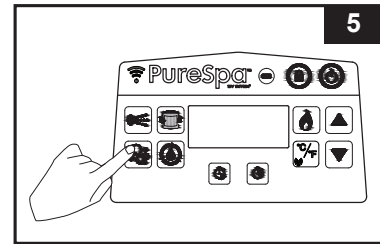

SET UP (continued)

4. Press the  button to turn on the control panel. Press the  button to inflate the spa tub wall for 8 to 10 minutes until it is firm to the touch but not hard (see drawing 5 & 6).
IMPORTANT: Do not over inflate or use high pressure air compressor to inflate.



5. Press the  button again to turn it off.
6. Replace the air valve cap back.
The cap is designed to be screwed on and off. Never exert force as this could cause the complete internal inflation system of the valve to come loose. See "Spa Tub Air Valve Fastening" for valve maintenance.

NOTE: If there is a need to replace the spa tub air pressure release valve core (5) due to wear and tear, use the included wrench (22) to unscrew the core from the valve base. Insert the replacement core and tighten with the wrench. Make sure the core is securely tightened (see drawing 7).

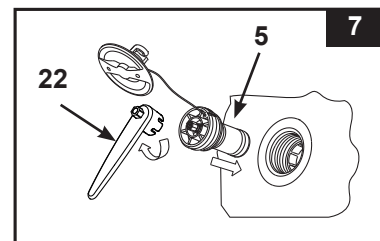

Inflate the Spa Cover Air Bladder

1. Open the inflation valve and insert the inflation hose (7) into the valve; press  to inflate until it is firm to the touch but not hard (see drawing 8).
2. Disconnect the inflation hose (7) from the air blower inflation outlet and the valve.
3. Replace the control base inflation latch back; close and recess the inflation valve.

NOTE: If there is a need to add some air to the spa tub wall or spa cover air bladder after they have been setup, refer to above "Inflate the Spa Tub Wall" and "Inflate the Spa Cover Air Bladder" sections. The cover air bladder is preinstalled inside the spa cover. If it needs to be reinstalled, place the uninflated air bladder inside the spa cover lip before inflating the bladder.

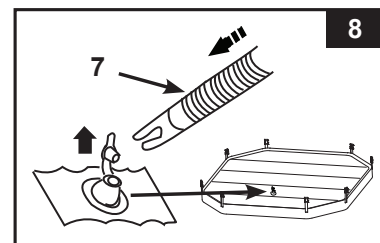

SET UP (continued)

Deflation

For Spa Tub Wall:

1. Unscrew the cap to reveal the stem, push the stem in and turn 90 degree right to secure it in the down position (see drawing 9).
2. Once the deflation is completed, push the stem in and turn 90 degree left to return it to the inflation position.
3. Replace the cap back.

NOTE: To deflate the spa tub for storage, see "STORAGE" section.

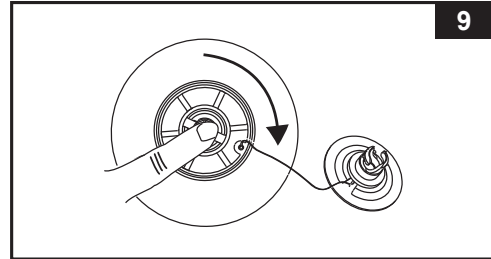

For Cover Air Bladder:

1. Pull valve cap out and squeeze the valve at its base until deflated.
2. Close and recess the valve back.



IMPORTANT

The spa tub inflation/deflation valve incorporates an "air pressure release" function that automatically releases excess air when the spa tub internal pressure is between 1.5 - 2.5 psi (0.103 - 0.172 bar).

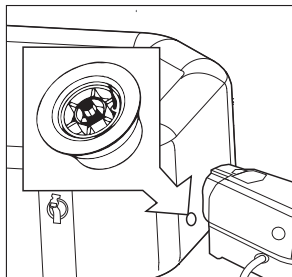

Air pressure release valve.

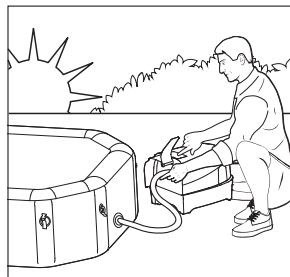

Inflation of spa in the morning.

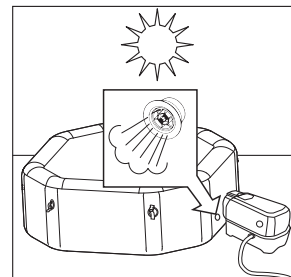

Air expands in the midday heat. Air pressure release valve kicks in and releases excess air.



Colder temperatures at night cause the spa to seem less inflated.

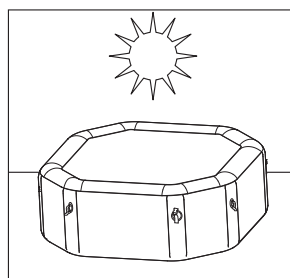

Air expands in the midday heat and correct air pressure is restored.

SET UP (continued)

Spa Control Unit Installation

1. Connect the spa control unit to the spa tub (**see drawing 10**). Hand-tighten the connectors securely. Do not use tools to tighten. Replace the control base side covers (**36**).

NOTE: Never attach external accessories not supplied with the kit to the spa tub or control base unit, as this will void the warranty.

CAUTION: Do not sit, lean, cover or place any objects over the spa control unit.

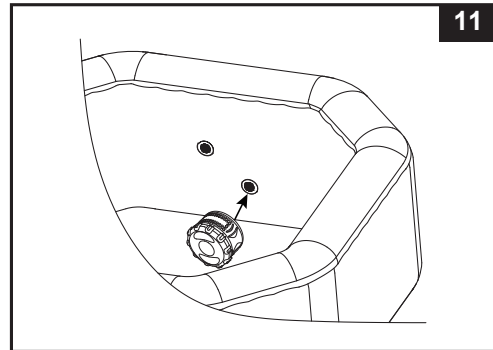
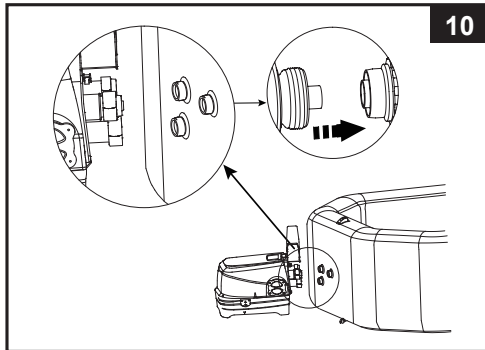

2. Attach the filter cartridge housing assembly to the inside of the spa tub outlet grid (**see drawing 11**). Inflate the spa tub first before installing filter pump fittings.
3. Before filling with water ensure the bottom drain valve caps are securely closed on the inside and outside.
4. Fill the spa tub with freshwater to a level between MIN and MAX marked on the inside of the spa wall. Do not over fill the spa. Never move the spa tub with water inside and/or with the control base attached to the spa as the spa or control base may be damaged.

WARNING: Never pour water with a temperature higher than 40°C (104°F) into the spa directly. It is recommended to fill the spa tub with lukewarm water for quick heating and energy saving.

5. Place the spa cover and spa air bladder (pre-installed in spa cover) over the spa tub, and make sure the spa cover buckles are locked using the key provided after pulling the buckled straps tight.

IMPORTANT: Inspect the spa cover regularly for leak, premature wear and tear or deterioration. Never use a damaged spa cover.

6. Ensure that the spa base is plugged into a properly located and sized electrical outlet and press the  button to turn on the control panel. Press the  button on the control panel to activate the heater, see "Spa Control Panel" operation section.

Spa Cover

The attachment buckles of the cover are locking buckles. Two keys are provided in the plastic bag with the manual and other accessories. Each buckle is marked with "locked" and "unlocked" symbols for easy operation: put the key into the slot on the buckle and turn it to the appropriate position to lock or unlock the buckle respectively.

To assure safety from unauthorized access, always put the cover on when spa is not in use and lock all buckles. Always keep the keys out of reach of children. In case you misplace the keys, you can use any similar size flat screwdriver to lock or unlock the buckles.

When the spa is being used, the cover should be placed in a clean, dry area, otherwise it can pick up dirt and bacteria. Covers should not be put on wooden tables or wooden decking because of the risk of bleaching the wood. A cover lifter, dedicated support or similar device, is recommended for ensuring that the cover, mostly its side facing the water, does not come into contact with the ground or any other dirty surfaces.

SALT LEVEL INFORMATION

The spa comes with a built-in saltwater sanitation system. Common salt (sodium chloride) is made up of two elements, sodium and chloride. During the installation of the device, a measured quantity of salt is dissolved in the SPA water to make it slightly salty. The SPA water flows through the sanitation system's electrolytic cell to produce chlorine. The chlorine dissolves in the water and instantly starts destroying bacteria and algae. It also oxidizes all other organic materials.

• Which kind of salt to use:

A specific type of salt must be used in swimming pools to protect the equipment. When buying salt, check that the salt conforms with the EN16401 standard for Chemicals for use in swimming pools. Consult your local pool store or contact the salt manufacturer if you need help with verifying you have the correct salt. **Do not use iodized salt, salt containing anti-caking agent (E535) or yellow (yellow prussiate of soda) colored salt.**

When choosing the pool salt for use within the EU, please also note that the European Chemicals Agency (ECHA) requires that salt (sodium chloride) be used from registered/authorized manufacturers listed in the ECHA Article 95 List in accordance with the Biocidal Product Regulation (BPR, Regulation (EU) 528/2012). For more information, please consult ECHA's website at <https://echa.europa.eu/information-on-chemicals/active-substance-suppliers>.

Use only Sodium Chloride Salts

Use only sodium chloride (NaCl) salt that is at least 99.4% pure. It is also acceptable to use water conditioning salt pellets (the compressed forms of evaporated salt). However, it will take a longer time for them to dissolve. Salt is added to the SPA water and the electrolytic cell uses the salt to create chlorine. The purer the salt the better the performance of the electrolytic cell.

• Optimum Salt Levels

The ideal salt level in the SPA water is between 2000-3000 ppm (parts per million). The optimal level is 2500 ppm. A too low salt level will reduce the efficiency of the sanitation system and result in low chlorine production. Too high a salt level may damage the power supply and cause corrosion to metal fixtures and accessories.

• Adding Salt

1. Switch the JET pump on to start the water circulation.
2. Keep the sanitation system turned off.
3. Evenly spread 4.4 lbs / 2 kg (for 4 adults') of salt around the inside perimeter of the SPA. For six adults': 5.5 lbs / 2.5 kg of salt.
4. Brush the SPA bottom to speed up the dissolving process. Do not allow salt to pile up on the bottom of the SPA. Run the JET pump for one hour to thoroughly dissolve the salt.
5. When all the salt is dissolved, press the sanitizer button  to activate the sanitation system (see "Sanitation System Operating Instructions" section), code "003H" is flashing and set the sanitation system to desired operating hours. **NOTE:** DO NOT press any other buttons on the control panel, and attach the spa cover during the sanitizing process.

• Removing Salt if Salt Level is too high

If too much salt has been added, the unit will beep and display "E92" (see "LED Code Chart"). If this happens, turn off the sanitation system by pressing the ON/OFF button , and unplug the spa. You will need to lower the salt concentration. The only way to do so is to partially drain the SPA and refill it with fresh water. Drain and refill approximately 25% of the SPA water until the "E92" alarm code disappears.

• Adding Salt if Salt Level is too low

If not enough salt has been added, the unit will beep and display "E91" (see "LED Code Chart"). If this happens, turn off the sanitation system by pressing the ON/OFF button , unplug the spa and wait 10 seconds. Plug and turn on the spa, add 1.1 lbs / 0.5 kg increment of salt until the "E91" alarm code disappears (see "Adding Salt" section).

OPERATION

SPA CONTROL PANEL

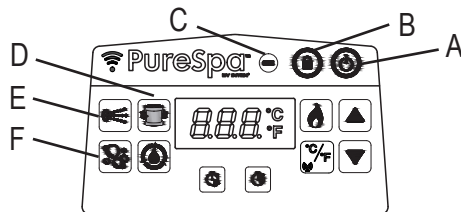

- A: On/Off Button
- B: Lock/Unlock Button
- C: Control Panel Battery Indicator
- D: Water Filter Button
- E: Water Jet Button
- F: Bubble Button



On/Off Button: Once the unit is plugged in, press this button to activate the control panel buttons. Press this button again to turn off all currently activated functions.



Lock/Unlock Button: Press and hold this button 3 seconds to lock/unlock the control buttons. If you forget to lock the keypad controls, the system will automatically lock it after 30 minutes of inactivity. The icon on the display is red when locked.

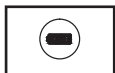



Control Panel Battery Indicator: The battery indicator will turn green when it is fully charged; turn red when it requires charging and flashing red when it is in charging mode.



Water Filter Button: This button turns the filter pump on and off. The water filter icon on the display is green when activated and flashing 002H which is the minimum preset operating hours. Press again to increase the preset time from 002H, 004H to 006H. Pressing the button after the maximum number of hours (006H) will turn off the filter pump and the LED display shows the spa water temperature. If you have selected too many hours keep pressing to repeat the cycle. Once the operating time is set, the LED display will stop flashing after 10 seconds and the filter pump starts working. The cycle repeats itself at the same time each day for the number hours selected.

If the heating system is activated it will override the filter pump preset time function.

To view the preset time while the filter pump is operating, press  button, the display will briefly flash the preset hours for 10 seconds and then display back the remaining operating hours. To adjust the preset time, press  button twice until the display is flashing and repeat previous steps.

NOTE: The built-in hard water treatment function works automatically in conjunction with the filtration system.



Water Jet Button: Use this button to activate the jet massage system. After 30 minutes of continues use, the jet massage system will automatically turn off. The water jet icon on the displays is green when activated. The angle of the water jet nozzles inside the spa tub wall can be adjusted manually.

CAUTION: Do not run jet system when the cover is attached, air pressure may accumulate inside the spa and cause irreparable damage and bodily harm.



Bubble Button: Use this button to activate the massage system, which has a 30-minute auto-shutoff feature. The bubble icon on the displays is green when activated.

CAUTION: Do not run Bubble system when the cover is attached, air can accumulate inside the spa and cause irreparable damage and bodily harm.

OPERATION (continued)

SPA CONTROL PANEL

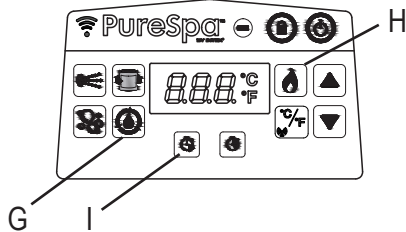

- G: Sanitizer Button
 H: Heat Button
 I: Heater Start Timer (HST) Button



Sanitizer Button: Use this button to activate and set operating hours for the sanitation system.



Heat Button: Press this button to activate the heating system. Press ▲ or ▼ to set the desired water temperature. The heater will continuously heat until the water temperature reaches the set temperature and then hold at that temperature. This is achieved by the heater restarting automatically whenever the water temperature drops 1-2°C (1.8-3.6°F) below the set temperature. When the flame icon on the display is red, the heating system is activated. When the flame icon turns green, the water is at the set temperature. The heating system is then at rest, but the filtration system will continue circulating water nonstop, unless manually turned off. If the heating system is reactivated, the filter pump will restart at the same time.

NOTE: To stop the filtration system while the heater is at rest mode, press the flame button first and then the filter button. Pressing the heat button only while the heater is at rest mode will turn off the heating system only and the filtration system will operate for 1 more minute before it turns off or continue with the filter pump preset operating hours. To turn the heater off while heating, press the flame button.

IMPORTANT: The following conditions will lead to slow water heating:

- The ambient temperature is lower than 50°F (10°C).
- Outdoor wind speed is above 8-12 mph (3.5-5.4 m/s).
- The jet or bubble function is activated when heating the spa water.
- The spa is not properly covered with the spa cover when the water is heating.



Heater Start Timer (HST) Button: Use this button to select a future start time for the heating system. Press this button and then press ▲ or ▼ to set the number of hours by which you wish to delay the start of the heating system, from 000 to 120 hours. The icon will flash red for a few seconds and then stays red. The information shown on the LED display alternates between the remaining hours before heater start and the water temperature. Once the countdown timer reaches 000, the heating system will start operating. To deactivate the function at any time, simply set the HST time back to 000. To readjust the preset hours, press the HST button twice and adjust the hours with ▲ and ▼ buttons.

Example 1: It is 9:00pm Monday evening and you would like the spa to be hot on Friday evening. Allowing for 24 hours for the spa to heat up (4 persons model about 1.5-2.5°C (3-4.5°F) per hour) the heater should be set to start on Thursday evening. With the Spa turned on, first press the Heat button and set your desired temperature. Press the HST button and then ▲ or ▼ until 072 hours is shown. The heater will start after 72 hours has passed (Thursday at 9:00pm) and will run until the desired temperature is attained. The heater will then cycle on and off to maintain the set temperature until turned off. To turn off the heater, press the flame button.

OPERATION (continued)

SPA CONTROL PANEL

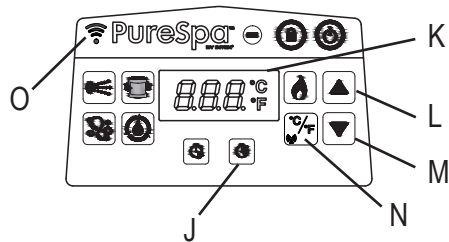

- J: Heater Duration Timer (HDT) Button
 K: LED Display
 L: Increase Button
 M: Decrease Button
 N: Celsius/Fahrenheit Toggle and Pairing Button
 O: WiFi LED Indicator



Heater Duration Timer (HDT) Button: Use this button to select the desired length of time the heating system should operate. Press this button and then press ▲ or ▼ to set the number of hours you wish the heater to operate before it automatically turns off, from 000 to 048 hours. The icon will flash red for a few seconds and then stays red. The heating system will operate for the amount of preset hours only. The timer takes priority over temperature, so the heater will shut off when HDT time runs out regardless if the preset spa water temperature is reached or not. During the HDT function, the information shown on the LED display alternates between the remaining heater operating hours and the water temperature. Repeat previous steps to reprogram this function. To deactivate the function at any time, simply set the HDT time back to 000. To readjust the preset hours, press the HDT button twice and adjust the hours with ▲ and ▼ buttons.

Example 2: Using the same scenario as example 1 above but rather than manually turning the heater off when you are finished, you would like the heater to turn off automatically on Saturday evening at 9:00pm. After going through the steps in example 1, press the HDT button and then the ▲ or ▼ button to select 048 hours. The heater will then run from Thursday at 9:00pm to Saturday at 9:00pm.

NOTE: If HST and HDT timers are both set, the LED display will first alternate between remaining time before the heater start and the water temperature, until HST timer runs out and the heater activates. Then the LED display alternates between remaining HDT time and water temperature until the HDT timer runs out as well.



LED Display: Once plugged in the LED displays the current water temperature automatically. If the control panel (3) is activated and away from the control base charging dock, the LED display will go blank after 5 minutes. Press any button to resume the control panel. Always check the control panel battery indicator. Recharge the control panel after each use.



Adjustment Buttons: Press the increase or decrease buttons to adjust the desire function settings. Press and hold the button will rapidly increase or decrease the numbers.



Celsius/Fahrenheit Toggle Button: The temperature can be displayed in either Fahrenheit or Celsius. The system's default is Celsius.

NOTE: The default temperature is 20°C (68°F). Temperature adjustment ranges from 10°C (50°F) to 40°C (104°F). To change temperature unit on your mobile device App screen, touch the current temperature number shown on the App screen to switch between (°C / °F).



Pairing Button: Touch this button for 5 seconds to begin spa pairing with your mobile device.



WiFi LED Indicator Status:

- **ON/Solid:** The product is paired up and connected to the home WiFi signal successfully.
- **Flashing:** Pairing mode stage.
- **OFF/Blank:** Disconnected or not connected to the home WiFi signal. Touch the pairing button for about 5 seconds to repeat the pairing process. If the problem still persists, check the "Troubleshooting" section for more details.

OPERATION (continued)

IntexLink App Setup User Guide

The IntexLink App allows you to turn on/off any function on your spa, and program a schedule for future use remotely even when not at home from your mobile device.





WiFi APP
QR Code

System and WiFi Router Requirement

The Spa control base hardware communicates via Bluetooth and 2.4GHz WiFi network supporting 802.11b/g/n wireless technology. The hardware **does not support 5GHz WiFi** networks. It is recommended that you turn off your 5GHz WiFi network during the App setup and pairing process.

WiFi Pairing





For a successful first time WiFi pairing between the spa wireless control panel and your mobile device, make sure:

- To turn on the “**Bluetooth**” function on your mobile device and allow “**Nearby Devices**” permission (IntexLink App info → App permissions → Nearby devices → Allow).
- To turn on “**Location access**” on your mobile device.
- To keep the wireless control panel on the spa control base charging dock.
- The area where the spa will be installed is within your WiFi router coverage range. The area shall be free from metallic walls/mesh and other objects that may interfere with or reduce the WiFi signal.
- Turn off the mobile data (2G, 3G, 4G and LTE) function on your mobile device first, and make sure your mobile device is connected to your WiFi router before pairing the device with the spa control panel. Check the WiFi signal strength is full by browsing the internet with your mobile device using the connected WiFi network and ensure the webpage loading speed is fast.
- Follow below step-by-step sequence.
 - 1) Scan the WiFi App QR code located on the control base rating label or on this manual to install the App. You may also download the “IntexLink App” from your App store.
 - 2) Touch the  power button on the spa control panel to turn on the spa and make sure the spa control base is powered on.
 - 3) Open the App, create a new account (for first time user) and login into the App.
 - 4) Touch the  pairing button on the spa control panel for 5 seconds until a “beep” sound is heard. The WiFi LED indicator will flash to begin pairing with your mobile device.
 - 5) Touch the “**Add Device**” or “” button on the App to search for nearby devices.
 - 6) Touch the Spa icon to be added or paired up with.
 - 7) Choose your wireless router and enter the WiFi router password, then touch “**Next**” to begin pairing.
 - 8) Once the Spa is added successfully, the pairing is completed. Touch the “**Done**” button to begin using the IntexLink App.

How to share your product / device:

















Open the App, touch the “Spa” icon, touch the setting () icon on the top right corner and then touch “Share Device”.

OPERATION (continued)





Heater Function Setting Examples			
 Temp set at (°C/F)	 HST	 HDT	Action
40/104	000H	000H	HST & HDT functions are off. Heating system has to be activated manually by pressing () button. See "Spa Control Panel" section for details. The heater will continuously heat until the temperature is reached and then hold at that temperature.
40/104	000H	005H	Turn the heater on and set a run time at which point the heater will turn itself off. The heater will continuously heat until the temperature is reached and then hold at that temperature until the 5 hours run time has expired, regardless if the water temperature has reached 40°C/104°F or not.
40/104	012H	005H	Turn the heater on some time into the future to a set temperature and set a run time at which point the heater will turn itself off. The heater will start after 12 hours and continuously heat until the temperature is reached and then hold at that temperature until the 5 hours run time has expired, regardless if the water temperature has reached 40°C/104°F or not.
40/104	012H	000H	Turn the heater on some time (in hours) into the future to a set temperature. The heating system will start after 12 hours, and continuously heat until the water reaches 40°C/104°F and then hold at that temperature. When the spa water temperature drops 1-2°C (1.8-3.6°F) below the set temperature the heating system will restart. When the flame icon on the display is red, the heating system is activated. When the flame icon turns green, the water is at the set temperature. The heating system is at rest and the filtration system will continue working nonstop.

Freeze Protection: the spa heater is programmed to automatically heat the water if the water temperature falls below 4°C (39°F). While the spa should be stored during the winter months, the system will protect the internal components in the event of occasional freezing temperatures. The spa must be plugged in and the GFCI/RCD reset. The system will engage the filter pump along with the heater and will operate both until the water reaches 10°C (50°F). If extended freezing weather is expected, please disassemble the spa and store it during winter according to the storage instructions. Once the self-heating program is triggered, it cannot be switched off on the control panel until the water temperature has reached at least 5°C (41°F), unless it is unplugged.

OPERATION (continued)

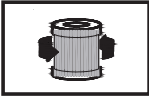
Function	ON	OFF	Information shown on LED display alternates between
	✓		Remaining filter pump time and water temperature
		✓	
		✓	
	✓	✓	Remaining HST time and water temperature
	✓		
		✓	
	✓	✓	Remaining HST time and water temperature first. Then remaining HDT time and water temperature.
	✓		
	✓		
	✓	✓	Remaining HDT time and water temperature
		✓	
	✓		
	✓		Water temperature and remaining sanitation time
	✓		
		✓	Water temperature and remaining sanitation time
	✓		

Due to power limitation the following functions can be activated together at the same time:

Filter Pump	Heater	Air Bubble	Sanitizer	Water Jet
				
✓	✓	✓	X	X
✓	✓	X	X	✓
✓	X	✓	✓	✓

Note: ✓ = can be activated at the same time; X = cannot be activated at the same time.

**Jet Nozzle Adjustment**

The amount of water and pressure coming out from the jet nozzles can be adjusted by turning the jet nozzle rim clockwise (maximum water output), counterclockwise (low water output) or anything in between.

Closing one or 2 jet nozzles will divert more water pressure to the other jet nozzles.

NOTE: Keep the spa control panel within 5m (16ft) range of the control base to ensure good wireless transmission signal.

SANITATION SYSTEM OPERATING INSTRUCTIONS



The spa control panel is resistant to water, but it is not designed to be completely submerged. Do not put the control panel in the water. Submersion could cause water to enter the panel causing damage to the electronics.

1. Activate the sanitation system:

Press the sanitizer button  on the control panel, this will activate the sanitation system as well as the filter pump. The sanitizer icon and the filter icon turn green. Flashing code "003H" appears on the control panel's LED, indicating that the unit is ready to be programmed.



2. Set operating hours for the sanitation system:

With the minimum preset hours (code "003H") flashing, press the sanitizer button  to increase the time from 003H, 005H to 008H hours (see "LED CODE CHART" section). Pressing the  button after the maximum number of hours (code "008H") will deactivate the sanitation function and the LED panel will display the spa water temperature. If you have selected too many hours keep pressing to repeat the cycle. Once the operating time is set, the display LED panel will stop flashing after 10 seconds and the sanitation system starts working. For first time use of the spa, set the operating hours to "008H". During the sanitation, the information displayed on the LED panel alternates between the spa water temperature and the remaining hours of sanitation.



After the cycle is completed the LED panel displays the water temperature. Test the water with the included test strips, and make sure the free chlorine level is between 2-4 ppm.

Note: DO NOT press any other buttons on the control panel, and attach the spa cover during the sanitizing process.

3. Readjust operating time if necessary:

During the sanitizing process, the operating hours can be re-adjusted if necessary. Press the sanitizer button, the LED code "003H" will flash. Repeat step 2.

4. Turn off the sanitation system manually if necessary:

During the sanitizing process, you can turn off the sanitation system manually. Simply press the ON/OFF button  on the control panel. The sanitation system will stop and the sanitizer icon light will disappear.

5. Restart the sanitation system:

When the programmed cycle ends, the LED panel displays the water temperature, the unit will stop sanitizing and the sanitizer icon light disappears. To restart the sanitation system, follow the above steps.

6. Test the SPA water regularly:

The free chlorine level in the SPA water may vary depending on the number of occupants, local water condition and sunlight intensity exposure (outdoor use). During the initial use of the spa, test the spa water at least 2 times per day with the included test strips to maintain the free chlorine between 2-4 ppm. After the free chlorine level appears to be stabilized, test the SPA water every week to maintain optimal sanitizing level.

Note: Flush all pipes with treated water by activating the bubble and jet functions for an hour a day.

LED CODE CHART

LED Reading	Definitions
001H	Operating Hour (1 hour remaining)
002H	Operating Hours (2 hours remaining)
003H	Operating Hours (3 hours remaining)
004H	Operating Hours (4 hours remaining)
005H	Operating Hours (5 hours remaining)
006H	Operating Hours (6 hours remaining)
007H	Operating Hours (7 hours remaining)
008H	Operating Hours (8 hours remaining)
E81	Transmission signal failure
E90	No water flow
E91	Alarm Code (Low Salt Level)
E92	Alarm Code (High Salt Level)
E94	Water temperature too low
E95	Water temperature too high
E96	System Error
E97	Dry-fire Protection
E99	Water temperature sensor broken
END	After 72 hours of continuous heating operation, the pump will hibernate automatically. The rapid heating function is disabled.
BLANK	Control panel battery has no power, place the control panel back on the control base charging dock to charge the battery and reactivate.

⚠ WARNING

NEVER use the spa if indicated water temperature is more than 40°C (104°F).

MAINTENANCE AND CHEMICALS

⚠ WARNING

Always unplug this product from the electrical outlet before removing, cleaning, servicing or making any adjustment to the product.

Water Sanitation

The spa owner must regularly check and keep the spa water sanitized with scheduled maintenance (daily, if necessary). Adding sanitizer and other chemical will control bacteria and viruses present in the spa water. The maintenance of a proper water balance through appropriate use of sanitizers is the single most important factor in maximizing the life and appearance of the spa tub as well as ensuring clean, healthy and safe water. Proper technique is important for water testing and treating the spa water. See your pool/spa professional for chemical, sanitizer, test kits and testing procedures questions.

CAUTION: ALWAYS FOLLOW THE CHEMICAL MANUFACTURER'S DIRECTIONS, AND THE HEALTH AND HAZARD WARNINGS.

Do not add chemicals if the spa is occupied. This can cause skin or eye irritation. Concentrated chlorine solutions can damage the spa tub. In no event is Intex Recreation Corp., Intex Development Co. Ltd., their related companies, authorized agents and service centers, retailers or employees liable to the buyer or any other party for costs associated with the loss of spa water, chemicals or water damage.

SPA WATER CHEMISTRY AND BALANCE

Parameter	Value ^a
Water clarity	clear view of the bottom
Total Alkalinity (TA) in mg/l	60 to 120
Calcium Hardness (CaCO ₃) in mg/l	150 to 250
Colour of the water	no colour should be observed ^{b, c}
Turbidity in FNU/NTU	max. 1.5 (preferably less than 0.5)
Nitrate concentration above that of fill water in mg/l	max. difference of 20 compared to the fill water concentration
Total organic carbon (TOC) in mg/l ^d	max. 4.0
Redox potential against Ag/AgCl 3.5 M KCl in mV	min. 650
pH value ^{e, f}	6.8 to 7.6
Free active chlorine (without cyanuric acid) in mg/l	0.3 to 1.5 ^g
Bromine in mg/l	2.0 to 4.0 ^h

When using alternative/additional disinfectants other appropriate parameters may be considered.

- a Consult national regulations and guidelines for any deviations.
- b Natural water sources may introduce water colouration.
- c Intentional water colouration is excluded.
- d When using organic compounds this value may be higher.
- e Subject to the flocculant(s) used (if any).
- f When pH is greater than 7.5 the free active chlorine is less than 50 %.
- g Commonly recommended concentration of free chlorine in aquatic settings is 0.3 to 1.5 mg/l. However, in order to ensure water hygiene in the spa setting where the water is heated and the water volume to user ratio is low, it is acceptable to temporarily exceed this concentration with manual dosage, provided the health of the user is not compromised. Therefore, a range of 2.0 to 4.0 mg/l is acceptable as also recommended by the U.S. Environmental Protection Agency and the Center for Disease Control. Do not use cyanuric acid.
- h Temporary exceeding due to manual dosage and low water volume to user ratio is acceptable, provided the health of the user is not compromised.

SPA WATER CHEMISTRY AND BALANCE (continued)

Particular care should be taken with chemical treatment of the water with special attention to disinfectant limits and control of pH values. The use of ozone or UV, where applicable, shall always be accompanied by residual disinfection with an oxidising biocide (e.g. Chlorine or Bromine or other biocide products, compatible with manufacturer's recommendations).

Improper use of chemicals may result in degradation, damage and other imperfections of the spa surface and other spa components (typically discolouration of materials, corrosion of metal parts).

Free chlorine: is the chlorine residual present in the spa water.

Result if too low – Inadequate level of disinfection.

Result if too high – cause odor problem, skin & eye irritation, corroded metals and other materials.

pH: a value that indicates how acidic or basic the spa water is.

Result if too low – Corroded metals, eye & skin irritation, and destruction of total alkalinity.

Result if too high – Scale formation, cloudy water, shorter filter/heater runs, eye & skin irritation, poor chlorine efficiency.

Total Alkalinity (TA): indicates the degree of the water's resistance to pH change. It determines the speed and ease of pH change, so always adjust total alkalinity before adjusting the pH level.

Result if too low – Corroded metals, eye & skin irritation. Low alkalinity will cause the pH to be unstable.

Result if too high – Scale formation, cloudy water, shorter filter/heater runs, eye & skin irritation, high chlorine demand.

Calcium Hardness (CaCO₃): refers to the amount of calcium and magnesium dissolved in the water.

Result if too low – Difficulty balancing water, corrosion of metal components, eye & skin irritation and water foaming.

Result if too high – Scale formation, cloudy water, eye & skin irritation, difficulty balancing water and filter/heater inefficiency.

Saturation Index (SI): temperature, calcium hardness concentration, total alkalinity and pH represent the main factors influencing scale formation. The tendency of water to either form scale or corrode is indicated by the Saturation Index (SI):

$$SI = pH + TF + CF + AF - 12.1$$

*Where: TF = Temperature Factor; CF = Calcium Hardness Factor; AF = Total Alkalinity Factor

Water Temperature		TF	Calcium Hardness (ppm)	CF	Total Alkalinity (ppm)	AF
(°C)	(°F)					
8	46	0.2	75	1.5	50	1.7
12	54	0.3	100	1.6	75	1.9
16	61	0.4	150	1.8	100	2.0
19	66	0.5	200	1.9	150	2.2
24	75	0.6	250	2.0	200	2.3
29	84	0.7	300	2.1	300	2.5
34	93	0.8	400	2.2	400	2.6
40	104	0.9	500	2.3	--	--

Test the water pH, Temperature, Calcium Hardness and Total Alkalinity levels. Use the equivalent Factors in the SI equation.

SI = 0, Balance

If SI > 0, Scaling or cloudy water condition.

If SI < 0, Corrosive to metals or eye & skin irritating condition.

The SI is considered satisfactory if the value is within -0.3 to +0.3 range. Zero being perfect.

SPA WATER CHEMISTRY AND BALANCE (continued)

SPA Water Adjustment

How to adjust the spa water chemistry when the levels are off the range.

CAUTION: Always follow the chemical manufacturer's directions, and the health and hazard warnings.

Total Alkalinity (TA) Adjustment

Remove the spa cover to aerate the water and use the included test strips to check the chemistry level. Ensure the chlorine level in the water is between 2-4 ppm first, as chlorine will affect the TA test result. If the TA level (and not the pH) is higher than 120 ppm, add appropriate chemical product to lower the TA level.

If the TA level is lower than 60 ppm, add appropriate chemical product to raise the TA level.

NOTE: After adjustment, retest the water after 24 hours and adjust again if necessary.

pH Adjustment

After the total alkalinity has been lowered to 120 ppm or raised to 80 ppm and the pH is still high or low, add appropriate chemical product to adjust the pH level between 6.8 and 7.6.

Calcium Hardness Adjustment

Use the included test strips to check the water hardness level and adjust it with appropriate chemical product.

WARNING

Handle all chemicals with care and wear extra personnel protective equipment including goggle and gloves. It is very important not to splash acid onto your skin or clothing, or into your eyes.

MINIMIZE HEAT LOSS AND ENERGY CONSUMPTION ADVICE

- 1) Always keep the spa cover on to minimize heat loss during heating of the spa between uses (but not while it is being used). Ensure the cover is fitted tightly, as per manufacturer's instructions to maximize insulation. It shall be recommended that the cover, when not in use, should be kept off the ground to retain its cleanliness (particularly the surface in close proximity to the water spa water surface). The cover should be stored in an appropriate location, where it cannot be damaged, or cause damage.
- 2) Check the set water temperature and consider lowering it for the times when the spa will typically not be in use.
- 3) Depending on external conditions, consider turning off the heater entirely if not using the spa for an extended period of time (where the spa provides this option, but still maintains residual disinfection/pH-values).
- 4) Consider that the comfortable temperature range during use may be lower than the maximum safe temperature.
- 5) Use the included insulating ground cloth underneath the spa to minimize heat loss through the bottom of the spa.
- 6) Maintain clean filters to preserve appropriate working conditions for the pump and avoid unnecessary water replacement and re-heating.

MAINTENANCE

Maintenance of Spa Water and Cartridge

Protect all the spa occupants from possible water-related illnesses by keeping the spa water clean and sanitized. Always practice good hygiene. To ensure proper spa water quality follow these procedures:

1. Inspect and clean the filter cartridge once a week, and change the filter cartridge as needed.
 - a. Unscrew the cartridge housing assembly from the spa tub wall and remove the cartridge (**see drawing 12**).
 - b. Use a garden hose to rinse off the cartridge. If the cartridge remains soiled and discolored it should be replaced. Keep spare cartridges on hand.
 - c. Reinstall the clean cartridge back into the cartridge housing and replace the cartridge housing assembly back onto the spa tub wall.
2. Change the spa water every 2~3 months, or it becomes cloudy and proper water chemistry does not clear it up. See "Spa Tub Drainage" and "Spa Tub Cleaning" sections for details.
3. Use spa chemicals to maintain proper water chemistry. Spa damage resulting from misuse of chemicals and mismanagement of spa water is not covered by the warranty.
4. All occupants must shower before entering the spa.

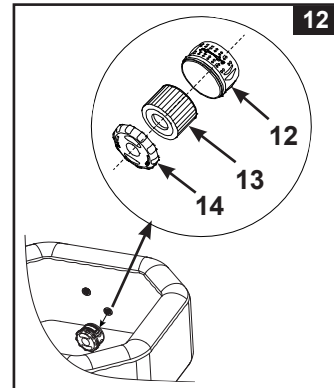

IMPORTANT

Unplug the power cord before cleaning the system. Cover the water inlet and outlet with the plugs to prevent water spillage. After completing all maintenance tasks, you must plug the power cord back in and remove the plugs.

Electrolytic Cell Cleaning

The electrolytic cell has a self cleaning function incorporated into the electronic control's programming. In most cases this self cleaning action will keep the cell working at optimum efficiency. In some regions, the SPA water is hard (high mineral content) which varies depending on the local water condition, this would cause deposits on the titanium plate and affect the sanitizing efficiency, so the cell may require periodic manual cleaning. To maintain maximum performance, we recommend that you open and visually inspect the electrolytic cell every two weeks for SPA water (Calcium hardness < 100 ppm) or weekly for SPA water (Calcium hardness > 350 ppm).

The following steps provide instructions on how to clean the cell.

Inspection and cleaning:

1. Turn off the spa and unplug the power cord from the electrical socket.
2. Unscrew the filter cartridge assembly from the spa tub wall, and use the included plugs (**15 & 23**) to cover the water inlet and outlet fittings from inside of the spa tub to prevent water from flowing out.
3. Remove the four screws from the transparent cover using a Phillips screwdriver (not included) and remove the cover from the spa control unit.

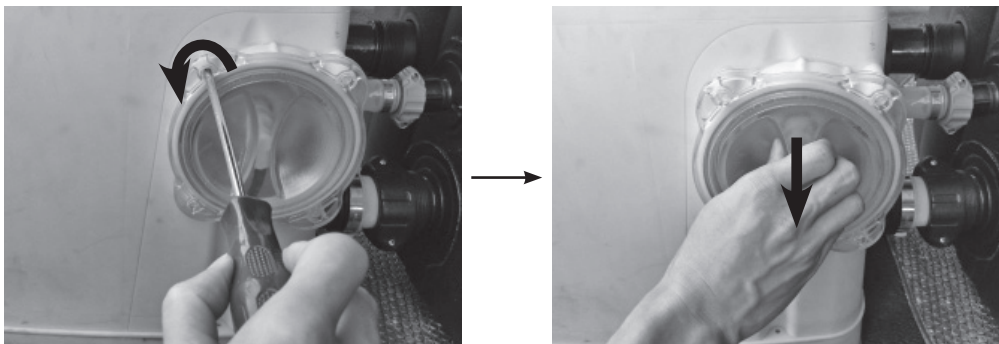

MAINTENANCE (continued)

4. Unplug the electrolytic cell cord. Unscrew the electrolytic cell nut in a counter-clockwise motion using the included electrolytic cell nut wrench (20).

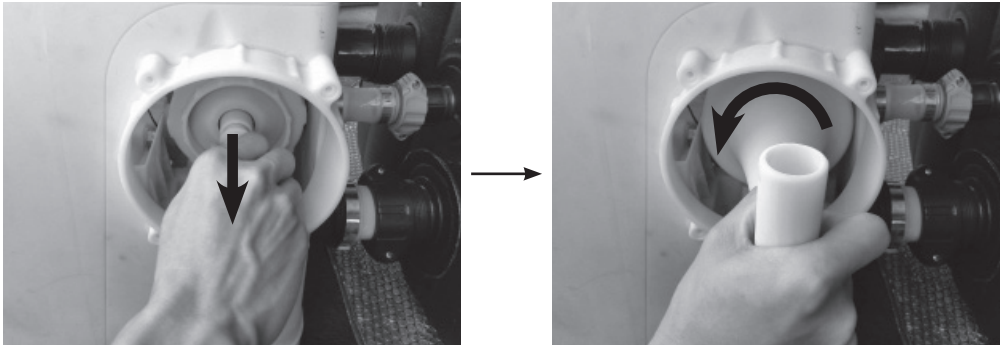

5. Pull out the electrolytic cell and place it in a container, pour kitchen grade vinegar into the container to soak the titanium plate for about one hour until no deposits remain.

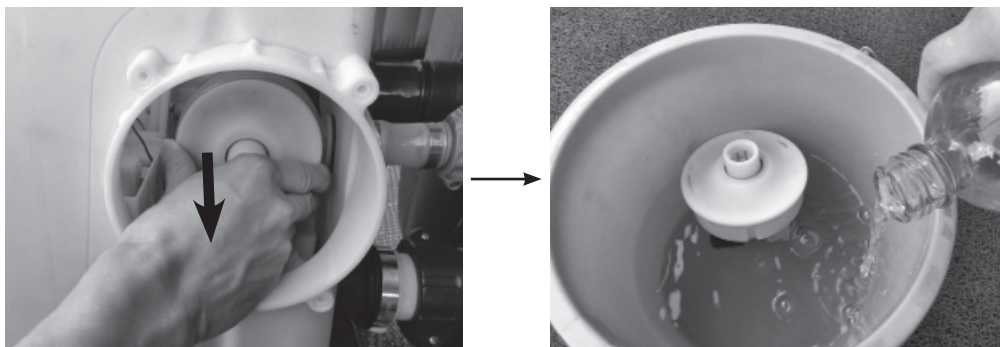

6. Remove the electrolytic cell and flush the titanium plate with fresh water. Be careful: Keep the electrolytic cell receptacle completely dry, do not let it come into contact with the vinegar and water.
7. Reverse the above steps to reinstall the electrolytic cell.
- NOTE:** Ensure the notch on the electrolytic cell is aligned with the ridge on the electrolytic cell housing.

INTEX® TEST STRIPS (PACKED WITH THE PRODUCT)

The Test Strips can test the "Free Chlorine", "pH", "Total Alkalinity" and "Calcium Hardness" levels at the same time. We recommend that you test the water chemistry weekly, and maintain the chlorine concentration at 2-4 ppm.

Directions and Use

1. Dip the entire strip into the water and remove immediately.
2. Hold the strip level for 15 seconds. Do not shake excess water from the strip.
3. Now compare the strip pad to the color chart on the packaging label. If necessary, adjust the chemical level in the spa water. It is very important, to use the proper technique when testing the water's chemical level. Read and follow the written strip instructions carefully.

MAINTENANCE (continued)

Spa Tub Drainage

1. Turn off and unplug the spa control unit.
2. Connect the drain valve adaptor to a garden hose and point the other end of the garden hose to a suitable draining area.
3. Remove the drain valve cap from outside of the spa tub and attach the drain valve adaptor to the drain valve (**see drawing 13**).
4. From inside of the spa tub, open the drain valve cap, water will start flowing out from the garden hose.
5. When the water stops draining, disconnect the spa control unit from the spa tub wall. Lift the spa tub wall from the side opposite the drain, leading any remaining water to the drain and emptying the spa completely (**see drawing 14**).
6. Turn over the spa tub to empty any remaining water (**see drawing 15**).
7. Use a clean towel to wipe up any remaining water and moisture on the spa tub and spa control unit.
8. Ensure the spa tub and spa control unit are thoroughly dried.
NOTE: The enclosed plugs (**15 & 23**) can be used to cover the water inlet and outlet connectors from the inside of the spa tub to prevent water from flowing out.

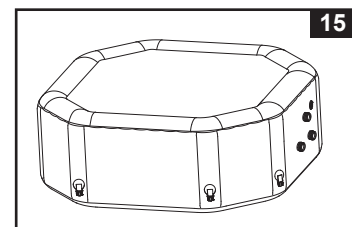
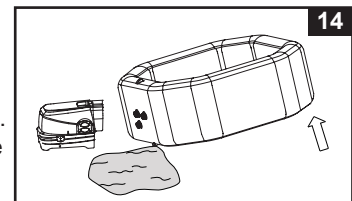
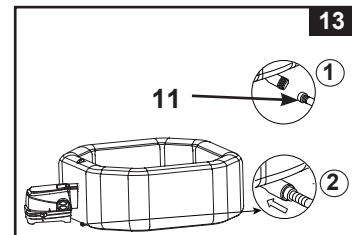

Spa Tub Cleaning

If dirt is visible in the water or water becomes cloudy and proper water chemistry does not clear it up, change the water and clean the spa tub. See "Spa Tub Drainage" section on how to drain the spa.

While empty, remove the cartridge housing from inside of the spa tub wall, clean and/or replace the filter cartridge. Use a sponge and mild soap solution to wipe away any soil or stains on the inside of the spa wall. Rinse thoroughly before refilling with clean water.

IMPORTANT: Do not use steel wool, hard brushes or abrasive cleaners.

Biofilm Removal

See your local spa professional for biofilm removal products and advice.

Spa Tub Air Valve Fastening

Check the spa tub air valve for leakage and tightness before use. If air is leaking from the air valve, use the provided wrench (**22**) to tighten the air valve as follow:

1. Make sure the spa tub is deflated, open the air valve cap and insert the wrench (**22**) into the air valve body (**see drawing 16**).
2. With one hand, hold the backside of the air valve base from the inside of the spa tub wall and turn the wrench (**22**) clockwise.

IMPORTANT: Never adjust the air valve base when the spa is in use or filled with water. Only use the air valve wrench if the air valve is loose or there is leakage around air valve base. Do not over tighten the air valve: over tightening can damage the valve. Just ensure the air valve is snug and not leaking.

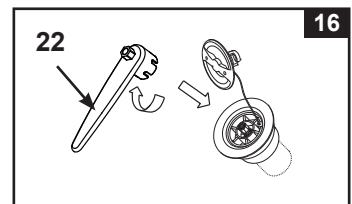

Spa Cover

Inspect the spa cover regularly for leaks, premature wear and tear, damage, or signs of deterioration. Never use a worn or damaged cover: it will not provide the level of protection required to prevent unsupervised access to the spa by a child.

Clean the cover inside and outside periodically using a sponge and a suitable solution that includes adequate disinfection (10 mg per liter of free chlorine). Do not use steel wool, hard brushes or abrasive cleaners.

MAINTENANCE (continued)

Spa Surround

Barefoot areas and relaxing areas around the spa shall be cleaned on a regular basis. No cleaning water may flow into the spa or spa water cycle. The dirt and cleaning agents shall be rinsed carefully to drain in the spa surround.

Spa Tub and Cover Air Bladder Repair

Use the enclosed repair patch to repair any puncture:

- Clean and dry the area to be repaired thoroughly.
- Remove the patch backing paper and press patch firmly over the puncture. Smooth out the surface to remove any air bubbles under the patch.

STORAGE

In regions subject to freezing temperatures, drain, clean, disassemble and properly store the spa set and related components indoors when the temperature drops below 4°C (39°F).

1. Drain and clean the spa following the "Spa Tub Drainage" and "Spa Tub Cleaning" sections.
2. Reverse set up instructions to deflate and disassemble the spa tub, spa control unit and spa cover air bladder.
3. To deflate the tub and the cover air bladder:
 - a) Open the deflation outlet cap (34) with the included wrench (22) (see drawing 17).
 - b) Insert deflation hose adaptor (35) into the deflation outlet.
 - c) Insert inflation hose (7) over the deflation hose adaptor (35).
 - d) Insert the other end of the inflation hose into the tub air valve or cover air bladder valve.
 - e) Press the air bubble  button to deflate.
 - f) When deflation is completed reverse above steps and ensures the deflation outlet cap (34) is securely fastened.

Caution: Only use for the purpose described in this manual. Keep the inflation hose away from water or small objects when the deflation function is activated to avoid damage to the blower motor.
4. Make sure all the spa components and accessories are thoroughly clean and dry before storage. Air-dry the spa tub in the sun for an hour before folding.
5. Fold the spa tub loosely and avoid any sharp corners to prevent damage or leakage to the spa tub liner.
6. Prepare additional new cartridges for next time use.
7. Store the spa tub and accessories indoors, in a dry, temperature controlled, between 0° – 40°C (32° – 104°F), storage location.
8. The original packing can be used for storage.

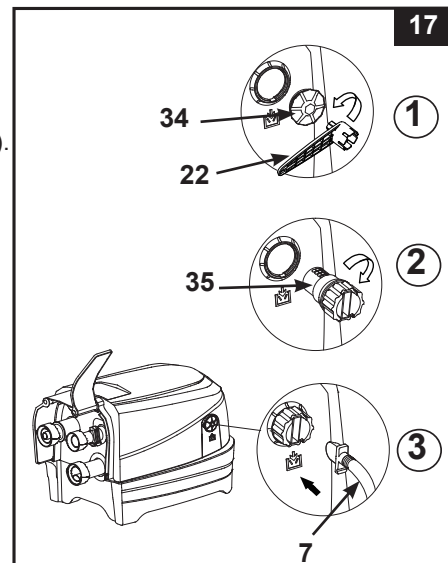



TROUBLESHOOTING

PROBLEM	CAUSE	SOLUTION
NO DISPLAY/SPA CONTROL UNIT DOES NOT WORK	<ul style="list-style-type: none"> • Spa is unplugged or off. • Control panel cable plug loose. • Power failure. • RCD tripped. • RCD broken. 	<ul style="list-style-type: none"> • Ensure the spa is plugged and switched on. • Ensure the control panel cable plug is firmly attached to the control base receptacle. • Check power source. • Reset the RCD. • Contact Intex Service Center.
HOUSEHOLD CIRCUIT BREAKER TRIPPED	<ul style="list-style-type: none"> • Circuit breaker under rated. • Overloaded circuit breaker. • An electrical fault in the line. 	<ul style="list-style-type: none"> • Ensure correct circuit breaker rating. • Provide a dedicated circuit breaker feeding the spa electrical outlet only. • Contact a qualify electrician to correct the electrical fault.
NOT HEATING PROPERLY	<ul style="list-style-type: none"> • Temperature set too low. • Dirty filter cartridge. • Water temperature decreasing during heater STANDBY mode. • Heating element failed. 	<ul style="list-style-type: none"> • Increase the temperature and attach the spa cover. • Clean or replace the filter cartridge in time. • If heater is in STANDBY mode, press the flame button twice to heat up the water to the set temperature. • Contact Intex Service Center.
JET FUNCTION DOES NOT WORK	<ul style="list-style-type: none"> • Jet pump is too hot. 	<ul style="list-style-type: none"> • Turn off and unplug the spa. Let it cool down and restart all over again. • If problem persists, contact Intex Service Center.
JETS OUTPUT ARE WEAK	<ul style="list-style-type: none"> • Low water level. • Obstruction in the suction inlet inside the tub. • Jet nozzles clogged or dirty. • Jet nozzles plumbing pipes damaged. 	<ul style="list-style-type: none"> • Add water between MIN and MAX level. • Ensure suction inlet is not covered or blocked. • Clean any dirt inside the jet nozzles. • Contact Intex Service Center.
JET AIR CONTROL KNOB NOT WORKING	<ul style="list-style-type: none"> • Jet nozzles clogged or dirty. • Jet airflow plumbing inside the spa tub damaged. 	<ul style="list-style-type: none"> • Clean any dirt inside the jet nozzles. • Contact Intex Service Center.
FILTRATION PUMP NOT WORKING	<ul style="list-style-type: none"> • Dirty filter cartridge. • Filtration inlet and/or outlet clogged. • Filter pump motor failed. 	<ul style="list-style-type: none"> • Clean or replace the filter cartridge in time. • Check and clean filtration inlet and outlet regularly. • Contact Intex Service Center.
WATER NOT CLEAN	<ul style="list-style-type: none"> • Cartridge assembly not properly attached. • Insufficient filtering time. • Dirty filter cartridge. • Improper water maintenance. • Filtration inlet and outlet clogged. 	<ul style="list-style-type: none"> • Ensure the cartridge assembly is properly attached. • Increase filtration time. • Clean or replace the filter cartridge in time. • Keep the spa water properly sanitized. Refer to the chemical manufacturer's instructions. • Check and clean filtration inlet and outlet regularly.
PUMP CONNECTORS ARE NOT LEVEL WITH THE SPA CONNECTORS	<ul style="list-style-type: none"> • One characteristic of PVC is that it changes shape, which is normal. 	<ul style="list-style-type: none"> • Elevate the pump with wood or another type of insulated material to bring the pump's connectors level with the spa's connectors.
TUB HAS A STRANGE SHAPE	<ul style="list-style-type: none"> • Expanded internal air pressure by strong sunshine. 	<ul style="list-style-type: none"> • Do not expose the spa to direct sunlight for extended period of time. • Check the air pressure and release air if necessary. During very hot weather, you must check to see whether it is necessary to release some air. This is to avoid any possible damage to the tub.

TROUBLESHOOTING (continued)

PROBLEM	CAUSE	SOLUTION
TUB LOSES AIR PRESSURE	<ul style="list-style-type: none"> • Air valve cap loose. • Air valve base loose. • Hole, cut or split on spa tub. 	<ul style="list-style-type: none"> • Ensure air valve cap is securely closed. • Fill up the spa tub with air then make sure the air valve base is tighten, see "Spa Tub Air Valve Fastening" section. • Put liquid soap and water in a squirt bottle and spray on seams. If there is a leak it will bubble. After you find the leak, clean and dry the leaking area, then apply the repair patch that comes with your spa.
LEAKING BETWEEN SPA TUB CONNECTORS AND CONTROL UNIT CONNECTORS	<ul style="list-style-type: none"> • Spa control base inlet/outlet connections not securely tight. • Spa control base inlet/outlet o-ring missing/dirty. 	<ul style="list-style-type: none"> • Tighten inlet and outlet connections. • Coat the o-ring with petroleum jelly for water proof. • Remove grid from inside spa with a screwdriver, ensure inlet/outlet O-ring is in place, clean and not damaged.
SPA IS TOO NOISY IN FILTRATION MODE ONLY	<ul style="list-style-type: none"> • Control base components not securely attached. • Control base ground not level and firm. • Spa filter motor failed. 	<ul style="list-style-type: none"> • Ensure control panel, back cover and all inlet/outlet are securely connected. • Ensure ground is level, firm and smooth. • Replace the failed filter motor with a new one.
INSUFFICIENT CHLORINE	<ul style="list-style-type: none"> • Insufficient operating time of the sanitation system and/or heater is running at the same time. • Chlorine loss due to intense sunlight exposure. • The bather load has increased. • Clogged or dirty electrolytic cell. 	<ul style="list-style-type: none"> • Increase the sanitation system operating time and ensure the heater is off during the sanitation process. See "Sanitation System Operating Instructions". • Use a SPA cover when the SPA is not in use and/or when the sanitation system is operating. • Increase the sanitation system operating time and test the water using the test strips. See "Sanitation System Operating Instructions". • Check and clean the cell if necessary. See "Maintenance".
BUBBLE AIR BLOWER DOES NOT WORK	<ul style="list-style-type: none"> • Air blower pump is too hot. 	<ul style="list-style-type: none"> • Turn off and unplug the spa. Let it cool down and restart all over again. • If problem persists, contact Intex Service Center.
AIR PRESSURE IS WEAK DURING INFLATION	<ul style="list-style-type: none"> • Hose adaptor o-ring missing. • Inflation hose adaptor not securely tighten. • Connection between the hose adaptor and blower inflation outlet, and between the inflation hose and inflation valve are loose. • Air blower failure. 	<ul style="list-style-type: none"> • Ensure the o-ring is in place. • Tighten/reinstall hose adaptor. • Finger tighten during inflation. • If problem persists, contact Intex Service Center.
AIR BUBBLES ARE NOT AS STRONG AS BEFORE	<ul style="list-style-type: none"> • O-ring missing between the control base air outlet and spa tub air inlet connections. • Air connection nut is not securely tight. • Air bubble channel passage inside the tub broken or leaking. • Air blower failure. 	<ul style="list-style-type: none"> • Ensure the o-ring is in place. • Finger tighten all nuts. • Use repair patch to repair any puncture. • If problem persists, contact Intex Service Center.

TROUBLESHOOTING (continued)

LED PANEL CODE	PROBLEM	SOLUTION
LED Panel Code Flash & Alarm On (NOTE: Always turn off the power before cleaning and servicing).		
E81	<ul style="list-style-type: none"> Transmission signal failure. 	<ul style="list-style-type: none"> Reset the RCD, restart all over again. Place the control panel within 5 m (16 ft) of the control base unit. Press and hold POWER button for 5 seconds to turn off and charge the panel again. If problem persists, contact Intex Service Center.
E90	<ul style="list-style-type: none"> No water flow. 	<ul style="list-style-type: none"> Turn off and unplug the control unit. Ensure the outlet cover grid is clean and free from obstructions. Clean or replace the cartridge, see Maintenance and Storage section. Ensure the in/outlet connections on the spa tub and filter pump are not blocked. Keep the spa water properly sanitized to ensure a clean and unclogged filter cartridge. If problem persists, contact Intex Service Center.
E91	<ul style="list-style-type: none"> Dirt or scale on titanium plates. Low salt level / No salt. Electrolytic cell cord is loose. Possible electrolytic cell failure. 	<ul style="list-style-type: none"> Remove the electrolytic cell for inspection. Clean it if necessary. See "Maintenance". Add salt. See "Salt Level Information". Ensure that the cell cord is plugged firmly into the cell receptacle. Contact Intex Service Center. Replace the cell if needed.
E92	<ul style="list-style-type: none"> High salt level. 	<ul style="list-style-type: none"> Partially drain the pool and refill it with fresh water. See "Salt Level Information". If problem persists, contact Intex Service Center.
E94	<ul style="list-style-type: none"> Water temperature too low. 	<ul style="list-style-type: none"> If the ambient temperature is below 0°C (32°F), we recommend not to use the spa. Turn off and unplug the control unit, add some warm water to raise the spa water temperature above 1°C (34°F), then press the  button to heat up the water to the desired temperature. If problem persists, contact Intex Service Center.
E95	<ul style="list-style-type: none"> Water temperature too high. 	<ul style="list-style-type: none"> Turn off and unplug the control unit. When the water has cooled down, plug the RCD and restart all over again. Turn the heater off, then press the filter and jet buttons to lower the water temperature. If problem persists, contact Intex Service Center.
E96	<ul style="list-style-type: none"> System Error. 	<ul style="list-style-type: none"> Turn off and unplug the control unit. Plug the RCD and restart all over again. If problem persists, contact Intex Service Center.
E97	<ul style="list-style-type: none"> Dry-fire Protection. 	<ul style="list-style-type: none"> Contact Intex Service Center.
E99	<ul style="list-style-type: none"> Water temperature sensor broken. 	<ul style="list-style-type: none"> Contact Intex Service Center.
END	<ul style="list-style-type: none"> After 72 hours of continuous heating operation, the pump will hibernate automatically. The rapid heating function is disabled. 	<ul style="list-style-type: none"> Press the  button to re-active the filter pump.
NO LED DISPLAY	<ul style="list-style-type: none"> LED display is off Charging Failed Control Panel failure. 	<ul style="list-style-type: none"> Press any button to reactivate the control panel. Reset the RCD, restart all over again and charge the control panel again. Make sure the surface between the back of the control panel and the control base charging dock is clean, dry and free of obstruction. If problem persists, contact Intex Service Center.

WIFI APP TROUBLESHOOTING

PROBLEM	CAUSE	SOLUTION
WIFI PAIRING FAILURE DURING THE FIRST TIME SETUP	<ul style="list-style-type: none"> Spa control base does not support WiFi App function, wrong model. Spa wireless control panel does not support WiFi App function. 	<ul style="list-style-type: none"> Only compatible with the Intex Spa Models showing "...WF.." characters in the model number as printed on the spa control base electrical rating label. Make sure the spa wireless control panel has the WiFi signal icon . Make sure the spa control base and wireless control panel are both compatible and support WiFi App function. Contact Intex Service Center.
	<ul style="list-style-type: none"> Wrong version of mobile device. 	<ul style="list-style-type: none"> Ensure the right version of mobile devices: <ol style="list-style-type: none"> iOS - Apple iPhone 6, 6 Plus and greater. Tablet compatibility is not optimized. Android – All Android phones. Tablet compatibility is not optimized.
	<ul style="list-style-type: none"> Incompatible mobile device operating system. 	<ul style="list-style-type: none"> Ensure the right version of operating system: <ol style="list-style-type: none"> Apple devices – iOS 11.0 and greater. Android devices – Android 6.0 and greater. For 6.0 and greater version, you must turn on the GPS signal on your mobile device for the first time pairing. Once you have successfully paired the spa and save it, you may turn off the GPS signal.
	<ul style="list-style-type: none"> Wrong router network band. 	<ul style="list-style-type: none"> Make sure you are connecting to a 2.4GHz network and try to pair the mobile device with the spa control panel again.
	<ul style="list-style-type: none"> Wrong network name. 	<ul style="list-style-type: none"> Make sure you are connecting to the right WiFi router signal and try to pair the mobile device with the spa control panel again. Make sure your mobile device and spa control panel are connected to the same WiFi router signal.
	<ul style="list-style-type: none"> Wrong WiFi password. 	<ul style="list-style-type: none"> Ensure correct WiFi router password. See WiFi pairing section.
	<ul style="list-style-type: none"> The setup spa location is too far from your WiFi router signal coverage range. 	<ul style="list-style-type: none"> Ensure your mobile device is connected to your WiFi router and can access and browse the internet. Remove the wireless control panel from the control base and bring it closer to your WiFi router while making sure it's within 5m (16ft) distance of the control base in order to prevent activating the error code E81 (transmission signal failure). Then try to pair the spa control panel with your mobile device. If it can be paired, your spa is too far away and you need to make sure the entire SPA is within your WiFi router signal coverage range. If you cannot move your spa, then you need to move your WiFi router or add a repeater/signal booster so that you can receive signals from your WiFi router at your setup spa location. Try to pair the mobile device with the spa control panel again.
	<ul style="list-style-type: none"> The App does not load. 	<ul style="list-style-type: none"> Force-quit the App, re-launch the App and try to pair the spa control panel with your mobile device again. Ensure the right version of mobile devices and operation system. Uninstall the App and reinstall it again. See WiFi pairing section.
	<ul style="list-style-type: none"> Bluetooth and WiFi not activated on your mobile device. IntexLink App "Nearby Devices" not activated. Your mobile device "Location access" is not activated. 	<ul style="list-style-type: none"> Turn on the Bluetooth and WiFi functions on your mobile device first. Allow "Nearby Devices" permission (IntexLink App info → App permissions → Nearby devices → Allow). Turn on "Location access" on your mobile device while using the App. Power off the spa control base and the wireless control panel, restart the spa and try to pair the spa control panel again. See "WiFi Pairing" section. If the problem persists, contact Intex Service Center.
	<ul style="list-style-type: none"> Wrong WiFi pairing sequence. 	<ul style="list-style-type: none"> Refer to "WiFi pairing" section.

WIFI APP TROUBLESHOOTING (continued)

PROBLEM	CAUSE	SOLUTION
OFFLINE AFTER SUCCESSFUL INITIAL SETUP AND PAIRING	<ul style="list-style-type: none"> • LED display is off. • E81. • Control panel charging failed. • Control Panel failure. 	<ul style="list-style-type: none"> • Press any button to reactivate the spa control panel. • Reset the GFCI/RCD, restart all over again and make sure the wireless control panel is fully charged. • Make sure the surface between the back of the wireless control panel and the control base charging dock is clean, dry and free of obstruction. • Try to pair the mobile device with the spa control panel again. • If problem persists, contact Intex Service Center.
	<ul style="list-style-type: none"> • WiFi signal failure. • WiFi LED indicator light is blank. 	<ul style="list-style-type: none"> • Reboot the WiFi router by powering it off for one minute and then turning it back on. Refer to your WiFi router's troubleshooting guide for more assistance. • Make sure your mobile device and spa control panel are connected to the same WiFi router signal, and your mobile device can access and browse the internet from the location where the spa is setup. • If you cannot move your spa, then you need to move your WiFi router or add a repeater/signal booster so that you can receive signals from your WiFi router at your setup spa location. • Power off the spa control base and the wireless control panel, restart the spa and try to pair the spa control panel again. • Try connecting using your mobile data function (2G, 3G, 4G and LTE), if it works, there may be a firewall that is preventing communications between your mobile device and the spa. • If the problem persists, contact Intex Service Center.
	<ul style="list-style-type: none"> • The App does not load. 	<ul style="list-style-type: none"> • Force-quit the App, re-launch the App and try to pair the spa control panel with your mobile device again. • Make sure your mobile device data function is activated and the device can access and browse the internet. • If the mobile data function (2G, 3G, 4G and LTE) works, try pairing the spa control panel to your Wi-Fi router network. See WiFi pairing section.
	<ul style="list-style-type: none"> • Other interferences. 	<ul style="list-style-type: none"> • Make sure there are no big metallic walls, objects between the spa and your WiFi router signal. • Make sure the surface between the back of the wireless control panel and the control base charging dock is clean, dry and free of obstruction. • Always return the wireless control panel to the spa control base charging dock after using the spa or when the spa is not in use.

IMPORTANT

If you continue to experience difficulty, please contact our Consumer Service Department for assistance. See separate "Authorized Service Centers" sheet.

FILTER PUMP MOTOR DISASSEMBLY

If there is a need to replace the filter motor (for qualified technician only), follow below steps to disassemble it:

IMPORTANT: You must drain out any remaining water inside the piping system of the control base before replacing any parts.

Tools required: One adjustable wrench and one Philip screwdriver.

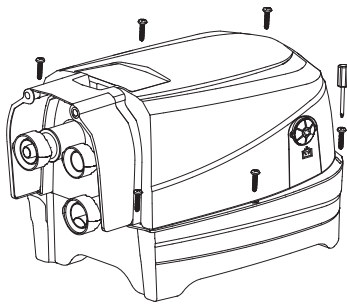

1

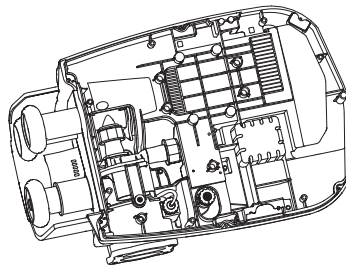

2

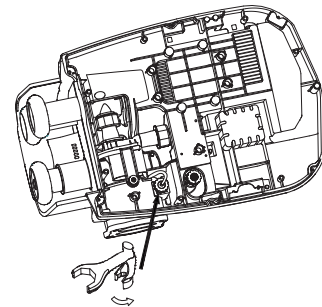

3

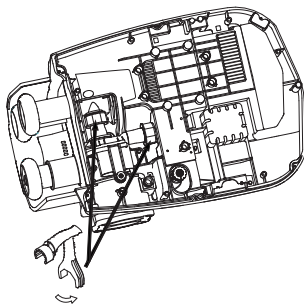

4

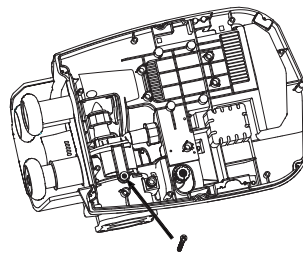

5

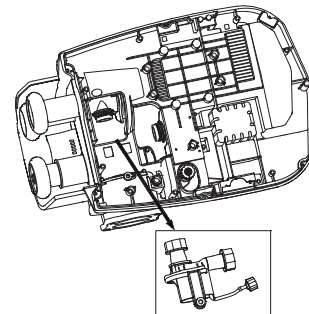

6

NOTE: The “special wrench tool” is included with the new filter pump motor replacement and not with the spa set.

For declaration of conformity, contact us at https://www.intexdevelopment.com/support/doc?lst_lang=2.

WARRANTY

Your PureSpa has been manufactured using the highest quality materials and workmanship. All Intex products have been inspected and found free of defects prior to leaving the factory. This limited warranty applies only to the PureSpa only.

This limited warranty is in addition to, and not a substitute for, your legal rights and remedies. To the extent that this warranty is inconsistent with any of your legal rights, they take priority. For example, consumer laws across the European Union provide statutory warranty rights in addition to the coverage you receive from this limited warranty: for information on EU-wide consumer laws, please visit the European Consumer Center website at http://ec.europa.eu/consumers/ecc/contact_en/htm.

The provisions of this limited warranty apply only to the original purchaser and are not transferable. This limited warranty is valid for a period of two (2) years from the date of the initial retail purchase. Keep your original sales receipt with this document, as proof of purchase will be required and must accompany warranty claims or the limited warranty will be invalid.

PureSpa Warranty – 2 Years

If you find a manufacturing defect in the PureSpa during the warranty period, please contact the appropriate Intex Service Center listed in the separate "Authorized Service Centers" sheet. If the item is returned as directed by the Intex Service Center, the Service Center will inspect the item and determine the validity of the claim. If the item is covered by the provisions of the warranty, the item will be repaired or replaced, with the same or comparable item (at Intex's choice) at no charge to you.

Other than this warranty, and other legal rights in your country, no further warranties are implied. To the extent possibly in your country, in no event shall Intex be liable to you or any third party for direct or consequential damages arising out of the use of your PureSpa, or Intex or its agents' and employees' actions (including the manufacture of the product). If your country does not allow the exclusion or limitation of incidental or consequential damages, this limitation or exclusion does not apply to you.

You should note that this limited warranty does not apply in the following circumstances:

- If the PureSpa is subject to negligence, abnormal use or application, accident, improper operation, improper voltage or current contrary to operating instructions, improper maintenance or storage;
- If the PureSpa is subject to damage by circumstances beyond Intex's control, including but not limited to, ordinary wear and tear and damage caused by exposure to fire, flood, freezing, rain, or other external environmental forces;
- If the PureSpa is used for any commercial purposes;
- To parts and components not sold by Intex; and/or.
- To unauthorized alterations, repairs or disassembly to the PureSpa by anyone other than Intex Service Center personnel.

The costs associated with the loss of pool water, chemicals or water damage are not covered by this warranty. Injury or damage to any property or person is not covered by this warranty.

Read the owner's manual carefully and follow all instructions regarding proper operation and maintenance of your PureSpa. Always inspect your product prior to use. This limited warranty will be void if use instructions are not followed.

READ BEFORE YOU START!

NOTE: This quick start guide provides important and useful tips before you start the setup of your spa. However, it does not address all aspects of spa installation and use, and you are still required to read, understand, and follow the owner's manual for proper installation, maintenance, and safe use of your spa.

- **Power:** This product draws a minimum of 13 AMPS. Most household circuits are 13 to 16 AMPS. If the circuit breaker trips, please check that no other appliances or other large loads are on the same circuit as the spa. Never use an extension cord. Unfold the line cord prior to use. Never place the plug on combustible materials.
- **Water Heating:** This heater when properly set up and running will raise the water temperature by 2°C per hour PROVIDED the spa cover is properly in place. Depending on the starting temperature of the Spa water and external air temperature, it will take some time to heat up. If the starting temperature of your tap water is 22°C and you wanted to raise it by 16° C to 38°C, the heating time would be 16°C/2°C per hour = 8 hours. For subsequent use the heating time can be shortened by maintaining an idle temperature in the spa (see HEATING AND WATER TEMPERATURE section). Be sure to keep the cover on the Spa when not in use.
- **RCD:** This product is provided with a RCD located at the end of the power cord. The RCD must be tested before each use. Do NOT use the Spa if the RCD does not function properly. (See owner's manual for proper testing of RCD instructions).
- **Filter Cartridge:** Keep the spa water properly sanitized to extend the life of the cartridge. Refer to the owner's manual for detailed information on spa water chemistry and balance.

UNFOLDING AND INFLATING YOUR SPA:

- When you unfold the inflatable spa tub you may notice the smell of the material that is normal for a new product out of the box. It is therefore recommended to inflate the product and leave it outdoors for a day to air and allow the new product smell to dissipate somewhat before filling the spa with water.
- Spread the ground cloth with the bubbles facing down over the cleared area where you intend to setup your spa.
- For spa inflation, familiarize yourself with the spring loaded valve on the spa tub and the inflation outlet on the control box unit to assure fast and proper inflation.

Inflation outlet tips:

- The larger end of the inflation hose attaches to the air outlet at the back of the control base unit (see owner's manual for drawings and further details).
- To attach the inflation hose to the air outlet, flip up the control base side cover to reveal the air blower inflation outlet. Pull out the latch to open the cover, insert the hose adaptor with hose and reattach the latch to the hose adaptor to secure it in place.
- When inflation is complete, release the latch, pull out the inflation hose, and secure the latch back onto the outlet.

NOTE: To avoid over-inflation, some air will escape through the bottom air-bubble outlet of the control base during inflation. This is normal.

Spring loaded valve tips:

- Upon removing the valve cap, note the spring loaded pin in the center of the valve. For inflation, the spring loaded pin should be in the up/raised position (closed position of the valve) as the air pressure of the pump will push the air through the valve during inflation. Check the valve pin and assure it is in the up/raised position before starting inflation.
- The pin can be pressed down and locked in the recessed position by pressing and turning it 90° clockwise with your finger – this is the open position of the valve that allows the air to flow out freely and that is used for deflation.

SAVE THESE INSTRUCTIONS

- To properly attach the inflation nozzle of the hose (the smaller end of the hose), push it into the valve and twist it clockwise until it locks with the valve (you may hear a click). To remove the nozzle upon inflation, twist it counterclockwise and pull it out of the valve.
- Once the spa tub is properly inflated, make sure to close the valve cap for the proper airtight seal.

HEATING AND WATER TEMPERATURE:

- **Filling with heated water:** You may use heated water to fill the spa, which will shorten the initial heat-up time. However, make sure not to use water exceeding the normal spa operating temperatures which are not to exceed 40°C. Water over 40°C will turn off the heating unit and is not considered safe. Always check the water temperature in your spa before use and refer to the owner's manual for detailed information on safe use.
- **Maintaining idle water temperature:** Your PureSpa is like any household appliance or a fixed spa, and for continuous use you may choose to set a certain idle temperature to be maintained in the spa when not in use. This will allow shorter heat-up time for when you decide to use it. For example, maintaining the spa water temperature at 30°C will allow reaching 38°C in approximately 4 hours. Remember, the water temperature increase is approximately 2°C per hour of heating (may vary depending on outside temperature and conditions), so plan your spa use accordingly.
NOTE: The Spa has a safety shut-off feature which will turn off the heating unit after 72 hours of continuous heating if the set temperature is not reached within that period. This may occur in cold external conditions that may prevent the set temperature from being reached. In that case your spa heating unit will shut off and display code "END", requiring pushing the temperature setting button and re-setting the temperature to re-start the heating unit. Try a lower more reachable temperature for the given conditions, which will not require re-starting the heating unit after 72 hours.
- **Water temperature during use:** When you are using the spa, the water temperature will naturally decrease slightly over time. The expected temperature decrease can be anywhere between 1°C and 2°C per hour depending on external conditions. As long as the heating unit is turned on with a set temperature, it will start heating the water automatically when water temperature drops by 1-2°C from the set temperature.
Example: If your set temperature is 39°C, the heater will not come on until the temperature drops to 37°C. If you should wish to heat it back up sooner, you can simply re-set the heater by turning it off and back on to start heating to your preferred temperature.

SPA COVER:

- The cover is an important part of your spa as it is crucial for heating up the water and maintaining the temperature when spa is not in use. Furthermore, it is a crucial safety element for prevention of unauthorized access to the spa especially by children.
- Note that the attachment buckles of the cover are locking buckles. Two keys are provided in the plastic bag with the manual and other accessories. Each buckle is marked with "locked" and "unlocked" symbols for easy operation: put the key into the slot on the buckle and turn it to the appropriate position to lock or unlock the buckle respectively.
- To assure safety from unauthorized access, always put the cover on when spa is not in use and lock all buckles. Always keep the keys out of reach of children.
- In case you misplace the keys, you can use any similar size flat screwdriver to lock or unlock the buckles.

SAVE THESE INSTRUCTIONS

A LIRE AVANT DE COMMENCER !

REMARQUE: Ce guide de démarrage fournit des conseils importants et utiles avant de démarrer l'installation de votre spa. Cependant il n'aborde pas tous les aspects de l'installation du spa et de son utilisation, il est fortement conseillé de lire, comprendre et suivre ce manuel pour l'installation, pour la maintenance ainsi que pour une utilisation appropriée de votre spa.

- **Alimentation :** Cet appareil requiert une puissance de 13 A minimum. La plupart des logements ont un circuit électrique de 13 à 16 A. Si le disjoncteur se déclenche, cela peut être dû au fait que d'autres appareils (notamment des appareils à forte consommation) utilisent le même circuit que le spa. N'utilisez pas de rallonge électrique. Déroulez le cordon d'alimentation avant utilisation. Ne jamais placer la fiche sur des matériaux combustibles.
- **Chauffage de l'eau :** Une fois correctement installé et en marche, le chauffe-eau permet d'élever la température de l'eau de 2°C par heure À CONDITION que le couvercle du spa soit bien en place. Selon la température ambiante et la température initiale de l'eau, le chauffage peut prendre plus ou moins de temps. Si la température initiale de l'eau du robinet est de 22°C et si vous souhaitez la monter à 38°C (soit 16°C de plus), la durée du chauffage sera donc de 16°C/2°C par heure, soit environ 8 heures. Pour les utilisations ultérieures, la durée du chauffage peut être réduite en maintenant une température de base dans le spa (voir section CHAUFFAGE ET TEMPÉRATURE DE L'EAU). N'oubliez pas de laisser le couvercle sur le spa quand vous ne l'utilisez pas.
- **DDR :** Cet appareil est équipé d'un DDR (disjoncteur différentiel à courant résiduel) situé au bout du câble. Le DDR doit être testé avant chaque utilisation. N'utilisez EN AUCUN CAS le spa si le DDR ne fonctionne pas correctement. (Voir le mode d'emploi pour savoir comment tester correctement le disjoncteur différentiel).
- **Cartouche de filtre :** La cartouche de filtre dure plus longtemps si l'eau reste correctement aseptisée en permanence. Veuillez vous référer au mode d'emploi pour plus de détails sur la chimie de l'eau et sur son équilibre.

DEPLIEZ ET GONFLEZ VOTRE SPA :

- Lorsque vous dépliez le spa gonflable vous pouvez sentir l'odeur de la matière, ce qui est normal pour un produit neuf qui vient d'être sorti de sa boîte. Il est donc recommandé de gonfler le produit et de le laisser s'aérer dehors durant une journée avant de mettre le spa en eau.
- Déplier le tapis de sol sur la zone propre d'installation prévue, les bulles contre le sol.
- Pour le gonflage du spa, familiarisez-vous avec la valve à baïonnette du spa ainsi que le boîtier de contrôle pour un gonflage rapide et efficace

Embout de gonflage:

- La plus grande extrémité du tuyau de gonflage se fixe à la sortie d'air à l'arrière de l'unité de contrôle (voir le manuel d'utilisation pour les schémas et détails).
- Pour attacher le tuyau de gonflage à la valve, relevez le cache pour révéler la valve de gonflage. Tirez sur le loquet pour ouvrir le cache, insérez l'embout du tuyau et rattachez le loquet sur l'embout du tuyau pour le fixer.
- Une fois le gonflage terminé, ouvrez le loquet, retirez le tuyau de gonflage et refixez le loquet sur la valve.

REMARQUE : Pendant le gonflage, vous remarquerez que de l'air s'échappe par l'orifice de sortie situé au fond. Ce phénomène est normal et a pour but d'éviter les risques de gonflage excessif.

Ressort pour embouts de valve:

- Lors du retrait du capuchon, notez la présence d'une soupape au centre de la valve. Pendant le gonflage la soupape doit être en position haute de sorte que la pression d'air exercée par la pompe pousse la valve durant le gonflage. Contrôlez la valve et assurez vous que la soupape soit en position haute avant de commencer le gonflage.
- La soupape peut être enfoncée et verrouillée d'1/4 de tour dans le sens des aiguilles d'une montre. La valve est en position ouverte, ce qui permet à l'air de sortir. Cette position sert au dégonflage.

CONSERVEZ CES INSTRUCTIONS

- Pour attacher correctement l'embout du tuyau (la petite sortie du tuyau), poussez-le dans la valve et tournez le dans le sens des aiguilles d'une montre jusqu'à la valve se verrouille (vous devriez entendre un "click"). Pour enlever l'embout de gonflage, tournez-le dans le sens contraire des aiguilles d'une montre et sortez-le de la valve.
- Une fois que le spa est gonflé, assurez-vous que la valve soit fermée afin que le joint soit étanche à l'air.

CHAUFFAGE ET TEMPERATURE DE L'EAU:

- Remplissage avec de l'eau chaude. Il se peut que vous utilisiez de l'eau chaude pour remplir le spa, ce qui va réduire le temps initial de chauffe. Cependant assurez-vous de ne pas utiliser de l'eau dépassant les températures normales de fonctionnement du Spa qui ne dépassent pas 40°C. Une eau au dessus de 40°C mettra hors tension le système de chauffage et n'est pas considérée sans danger.
- Maintenir une température d'eau idéale : Votre spa est semblable à un appareil ménager ou à un spa fixe et pour continuer à l'utiliser vous devez le maintenir à une température idéale lorsqu'il n'est pas utilisé. Cela va permettre de raccourcir le temps de chauffe lorsque vous voudrez l'utiliser. Par exemple, si vous maintenez la température à 30°C cela va permettre d'atteindre 38°C en environ 4 heures. Rappelez-vous que la température de l'eau augmente d'approximativement 2°C par heure (cela dépend des conditions météo et de la température extérieure). Utilisez donc votre Spa en fonction.

NOTE: Le spa possède une fonction d'arrêt automatique/sécurité qui arrête le système de chauffe après 72 heures lorsque la température n'est pas atteinte dans cette période. Cela peut se produire lorsque la température extérieure est basse. Par conséquent, la température programmée ne pourra pas être atteinte. Dans ce cas le système de chauffage de votre spa s'arrêtera et affichera le mot "end", nécessitant d'appuyer sur le bouton de température et de re-programmer le système de chauffage. Essayez une température plus facilement atteignable, en adéquation avec les conditions extérieures, qui n'entraînera pas un redémarrage du système après 72 heures.

- Température de l'eau pendant l'utilisation: Lorsque vous utilisez le spa, la température de l'eau va naturellement légèrement diminuer au fil du temps. Les baisses de températures prévues peuvent être entre 1°C et 2°C par heure, tout cela dépend bien entendu des conditions extérieures. Tant que le système de chauffage est en marche avec une température en mémoire, il chauffera automatiquement dès que l'eau descendra 1-2°C en dessous de la température programmée.

Exemple: Si votre température programmée est de 39°C, le chauffage ne se mettra pas en route avant que la température descende à 37°C. Si vous souhaitez faire re-chauffer l'eau plus tôt, vous pouvez reprogrammer simplement la température en arrêtant l'appareil et en programmant votre nouvelle température.

COUVERTURE DU SPA:

- Le couvercle est une partie importante de votre spa, il est crucial pour chauffer et pour maintenir la température lorsque votre spa n'est pas utilisé. Par ailleurs, il est un élément crucial de sécurité pour prévenir tout risque de noyade en particulier chez les enfants.
- Notez que les boucles de fixation du couvercle sont des boucles qui se verrouillent. Deux clés sont prévues à cet effet dans le sac en plastique avec le manuel et les différents accessoires. Sur chaque boucle on trouve les mots "locked" et "unlocked". Il suffit de mettre la clef dans la fente et de la tourner dans la position adéquate.
- Pour assurer la sécurité, il faut toujours mettre le couvercle lorsque le spa n'est pas utilisé et verrouiller les boucles, et toujours garder les clés hors de portée des enfants.
- Si vous perdez les clés, vous pouvez utiliser n'importe quel tournevis plat de taille similaire pour verrouiller ou déverrouiller les boucles.



CONSERVEZ CES INSTRUCTIONS

LEA ATENTAMENTE LAS INSTRUCCIONES ANTES DE ESTE PRODUCTO

NOTA: Esta guía rápida proporciona consejos útiles e importantes antes de que proceda a la utilización de su spa. Entretanto, este documento no cubre todos los aspectos de la instalación y utilización del producto, por lo que Usted deberá leer, entender y seguir todas las instrucciones del manual del propietario para una adecuada instalación, mantenimiento y utilización segura de su spa.

- Alimentación: Este producto necesita como mínimo 13 amperios. La mayoría de los circuitos eléctricos domésticos son de entre 13 y 16 amperios. Si se activa el disyuntor, compruebe que no haya otros aparatos o grandes cargas conectados al mismo circuito que el spa. No use cables alargadores. Desenrolle el cable antes de usarlo. Nunca coloque el enchufe sobre materiales combustibles.
- Calentamiento del agua: Si está correctamente configurado y en funcionamiento, este dispositivo de calentamiento calentará el agua a 2 °C por hora, SIEMPRE QUE la tapa del spa esté bien colocada. En función de la temperatura de partida del agua del spa y de la temperatura del aire exterior, el agua tardará más o menos en calentarse. Si la temperatura de partida del agua de su grifo es de 22 °C y desea aumentarla en desde 16 °C hasta 38 °C, el tiempo de calentamiento sería de 16 °C / 2 °C por hora = 8 horas. Para las siguientes utilizaciones del spa, se puede acortar el tiempo de calentamiento manteniendo una temperatura en estado de reposo en el spa (consulte la sección CALENTAMIENTO Y TEMPERATURA DEL AGUA). Asegúrese de mantener la tapa colocada sobre el spa mientras no lo esté utilizando.
- RCD: Este producto está equipado con un RCD (interruptor de circuito de accionamiento rápido/dispositivo de corriente residual) ubicado en el extremo del cable de alimentación. Deberá revisarse el RCD antes de cada uso. NO use el Spa si el RCD no funciona correctamente (Consulte el manual del usuario para probar de forma adecuada las instrucciones del RCD (Dispositivo de corriente residual)).
- Cartucho del filtro: Mantenga el agua del spa en un correcto estado sanitario para ampliar la vida útil del cartucho. Consulte el manual de instrucciones del fabricante para obtener información detallada sobre la química y el equilibrio del agua del spa.

DESPLEGAR Y HINCHAR SU SPA:

- Al desplegar el spa hinchable, este desprenderá un olor característico de productos nuevos. Es recomendable hincharse el producto y dejarlo ventilar durante un día para permitir que el olor se disipe antes de llenar de agua el spa.
- Extienda el tapiz de suelo con las burbujas para abajo sobre un área limpia donde Usted desee montar su spa.
- Antes de hincharse el producto, procure conocer el funcionamiento la válvula de conexión del spa y de la salida del aire en el cuadro de control para asegurar un rápido y correcto hinchado.

Consejos para salida de aire :

- La parte más larga de la manguera de hinchado se conecta a la salida de aire en la parte posterior de la unidad de control (Vea el manual del propietario para esquemas y detalles).
- Para conectar la manguera de inflado a la salida de aire, gire hacia arriba la cubierta lateral de la base de control para descubrir el soplador de aire Salida de inflado. Tire del cierre para abrir la cubierta, inserte el adaptador de la manguera con la manguera y vuelva a enganchar el cierre al adaptador de la manguera para fijarlo en su lugar.
- Cuando finalice el inflado, libere el cierre, saque la manguera de inflado y fije el cierre de nuevo en la salida.

NOTA: Para evitar un inflado excesivo, parte del aire escapará por la toma de burbujas de aire situada en la parte inferior de la base de control durante el inflado, lo cual es normal.

Consejos sobre la válvula de resorte:

- Al quitar la tapa de la válvula, habrá un botón en el centro de la válvula. Para el hinchado, este botón tiene que estar levantado (posición cerrada de la válvula) porque la presión de aire de la bomba empujará el aire por la válvula durante el hinchado. Verifique el botón y asegúrese de que está levantado antes de empezar el proceso de hinchado.
- Para bajar el botón y bloquearlo, debe presionarlo y girarlo 90° en sentido horario – esta es la posición abierta que permite que el aire salga libremente y es utilizada para el vaciado.

GUARDE ESTAS INSTRUCCIONES

- Para conectar correctamente la manguera (la parte más pequeña de la manguera), colóquela en el interior de la válvula y gírela en sentido horario hasta que se bloquee (se oirá un click). Para retirar la manguera, gírela en sentido anti horario.
- Una vez que el spa esté totalmente lleno, asegúrese de cerrar la tapa de la válvula para evitar escape de aire.

CALENTAMIENTO Y TEMPERATURA DEL AGUA:

- Llenado con agua caliente: Se puede utilizar agua caliente para llenar el spa, lo que acortará el tiempo de calentamiento. Entretanto, asegúrese de no ultrapasar la temperatura normal del spa que es de 40°C, máximo. Si la temperatura está por encima de los 40°C, el calentador se apagará y, además, no se puede considerar un procedimiento seguro. Siempre verifique la temperatura del agua antes del uso y lea el manual de instrucciones para informaciones detalladas de seguridad.
- Mantener la temperatura del agua: El PureSpa funciona como cualquier otro aparato o spa y se puede fijar una temperatura que se mantenga mientras el spa no está siendo utilizado. Esto disminuirá el tiempo de calentamiento cuando se decida usar el spa. Por ejemplo, mantener la temperatura a 30°C, permitirá alcanzar los 38°C en, aproximadamente, 4 horas. Recuerde que la temperatura sube, aproximadamente 2°C por hora (dependiendo de la temperatura y condiciones exteriores), por eso hay que programar el spa correctamente.
NOTA: El Spa tiene un dispositivo de seguridad que apaga el calentador después de 72 horas de calentamiento continuo si no se alcanza la temperatura programada en este periodo de tiempo. Esto puede ocurrir cuando la temperatura exterior es muy baja e impide que el agua alcance la temperatura deseada. En estos casos, el calentador se apagará y un mensaje "END" aparecerá en la pantalla, lo que requiere que se vuelva a programar la temperatura y se reinicie el calentador. Se aconseja bajar la temperatura deseada en el caso de que las temperaturas externas sean bajas para evitar que se tenga que reiniciar el aparato después de las 72 horas.
- Temperatura del agua durante el uso: Cuando se utiliza el spa, la temperatura del agua tiende a bajar natural y gradualmente después de un cierto tiempo. Esto puede significar una bajada de 1°C a 2°C por hora dependiendo de las condiciones climáticas exteriores. Si el calentador está encendido con una temperatura programada, este empezará a calentar el agua tan pronto baje 1-2°C la temperatura programada.
Ejemplo: Si se programa 39°C, el calentador no empezará a funcionar hasta que temperatura no llegue a los 37°C. Si se desea que el agua se empiece a calentar antes de que baje los 2 °C , solamente hay que apagar el calentador y volver a encenderlo.

COBERTOR DEL SPA:

- El cobertor es una parte importante del spa y es esencial para calentar y mantener la temperatura del agua cuando el spa no está en uso. Además, es imprescindible para evitar el acceso no autorizado al spa, principalmente por niños.
- Las hebillas del cobertor son cerradas con llave. Se incluye dos llaves en la bolsa de plástico del manual donde se encuentran también, otros accesorios. Cada hebilla está marcada con símbolos "cerrado" e "abierto": coloque la llave en el lugar apropiado gírela hasta la posición adecuada.
- Para asegurar que no se podrá acceder al spa sin autorización, siempre cúbralo con el cobertor cuando no esté en uso. Siempre mantenga las llaves fuera del alcance de los niños.
- En caso de que se pierdan las llaves, se puede usar un destornillador del tamaño similar para abrir y cerrar las hebillas.

GUARDE ESTAS INSTRUCCIONES

VOR BEGINN BITTE DURCHLESEN!

Deutsch

244
IO

BEACHTEN SIE: Diese Kurzanleitung liefert Ihnen, bevor Sie mit der Installation Ihres Whirlpools beginnen, wichtige und nützliche Tipps. Allerdings befasst sich die Anleitung nicht mit allen Aspekten der Spa Installation und dessen Nutzung. Deshalb ist es für Sie erforderlich, dass Sie die Bedienungsanleitung für die ordnungsgemäße Installation, Wartung und sichere Nutzung Ihres Whirlpools sorgfältig durchlesen, verstehen und auch befolgen.

- **Netzstrom:** Dieses Produkt benötigt mindestens 13 Ampere. Die meisten Haushaltsstromkreise haben eine Stromstärke von 13 bis 16 Ampere. Wenn der Schutzschalter ausgelöst wird, vergewissern Sie sich bitte, dass keine anderen Geräte oder andere große Ladungen am selben Stromkreis wie der Whirlpool angeschlossen sind. Verwenden Sie keine Verlängerungskabel. Vor dem Gebrauch das Netzkabel auseinanderwickeln. Den Stecker niemals auf brennbare Materialien legen.
- **Erwärmen des Wassers:** Dieses Heizelement, sofern korrekt installiert und funktionsfähig, erwärmt die Wassertemperatur um 2°C pro Stunde, VORAUSGESETZT die Abdeckung des Whirlpools liegt an ihrem Platz. Je nach Anfangstemperatur des Whirlpool-Wassers und der externen Temperatur dauert es eine Weile, bis sich das Wasser erwärmt. Wenn die Anfangstemperatur Ihres Leitungswassers bei 22°C liegt und Sie möchten die Temperatur um 16° C bis 38°C erhöhen, würde die Erwärmungszeit 16°C/2°C pro Stunde = 8 Stunden betragen. Für den anschließenden Gebrauch kann die Erwärmungszeit verkürzt werden, indem Sie eine Stand-by-Temperatur im Whirlpools aufrechterhalten (siehe Abschnitt ERWÄRMEN UND WASSERTEMPERATUR). Achten Sie darauf, dass die Abdeckung auf dem Whirlpool liegt, wenn es nicht in Gebrauch ist.
- **FI:** Dieses Produkt ist mit einem FI am Ende des Netzkabels versehen. Der FI muss vor jedem Gebrauch getestet werden. Benutzen Sie den Whirlpool NICHT, wenn der FI nicht ordnungsgemäß funktioniert. (Siehe Handbuch für Anleitungen zur korrekten RCD-Prüfung).
- **Filtereinsatz:** Achten Sie darauf, dass das Whirlpool-Wasser stets richtig desinfiziert ist, um die Lebensdauer des Einsatzes zu verlängern. Ausführliche Informationen über die chemische Balance des Whirlpool-Wassers finden Sie im Handbuch.

ENTFALTEN UND AUFBLASEN IHRES SPA:

- Wenn Sie den aufblasbaren Whirlpool entfalten, könnten Sie feststellen, dass das Material einen außergewöhnlichen Geruch aufweist. Dies ist bei einem neu ausgepackten Artikel normal. Es wird daher empfohlen, das Produkt aufzublasen und es für einen Tag an der frischen Luft stehen zu lassen, damit sich der Geruch vor dem Befüllen des Whirlpools mit Wasser etwas verflüchtigt.
- Breiten Sie die Unterlagsplane an jener Stelle aus, wo Sie Ihr Pool errichten möchten, so dass die Blasen nach unten zu der dem freien Gelände zugewandten Seite liegen.
- Für das Aufblasen des Spas, machen Sie sich mit dem federbelasteten Ventil am Whirlpool und dem Luftauslass an der Kontrollstation vertraut, damit ein schnelles und ordnungsgemäßes Aufblasen möglich ist versichern können.

Aufblasventil Tipps:

- Das größere Ende des Füllschlauchs wird an der Luftauslassöffnung an der Rückseite der Kontrollstation angebracht (für Zeichnungen und weitere Details siehe Bedienungsanleitung).
- Zum Anbringen des Füllschlauchs am Luftauslass, die Seitenabdeckung der Kontrollbasis hochklappen, um die Aufblasöffnung des Luftgebläses freizulegen. Lasche herausziehen, um die Abdeckung zu öffnen, Schlauchadapter mit Schlauch in die Öffnung stecken und die Lasche wieder am Schlauchadapter befestigen, um ihn zu fixieren.
- Wenn das Produkt komplett aufgepumpt ist, Lasche lösen, Füllschlauch herausziehen und die Lasche wieder an der Auslassöffnung befestigen.
HINWEIS: Um ein übermäßiges Aufpumpen zu vermeiden, wird etwas Luft durch den unteren Luftauslass der Kontrollbasis während des Aufpumpens entweichen. Dies ist völlig normal.

Federbelastetes Ventil - Tipps:

- Nach Entfernen der Ventilkappe, beachten Sie den gefederten Stift in der Mitte des Ventils. Zum Befüllen sollte sich der federbelastete Stift in der nach up/erhöhten Stellung (Schließstellung des Ventils) befinden, weil der Luftdruck der Pumpe während dem Aufblasen die Luft durch das Ventil drücken wird. Überprüfen Sie den Ventilstift und versichern Sie sich, dass er sich in der up/erhöhten Position befindet, bevor die Inflation beginnt.
- Der Stift kann nach unten gedrückt und in der versenkten Position, durch Drücken und Drehen mit den Fingern um 90° im Uhrzeigersinn, verriegelt werden. Dies ist die offene Position des Ventils, das die Luft frei ausströmen lässt und für das Ablassen verwendet wird.

HEBEN SIE DIESE BEDIENUNGSANLEITUNG AUF

- Um die Aufblasdüse des Schlauches richtig zu befestigen (das kleinere Ende des Schlauches), schieben Sie dieses in das Ventil und drehen es im Uhrzeigersinn, bis es am Ventil einrastet (Sie können ein Klicken hören). Um die Aufblasdüse danach wieder zu entfernen, drehen Sie diese gegen den Uhrzeigersinn und ziehen Sie sie aus dem Ventil.
- Sobald der Whirlpool richtig und vollständig aufgeblasen ist, stellen Sie ein ordnungsgemäßes, luftdichtes Schließen der Ventilkappe sicher.

HEIZEN UND WASSERTEMPERATUR:

- Befüllung mit beheiztem Wasser: Sie können erwärmtes Wasser verwenden um das Spa zu füllen, welches die anfängliche Aufheizzeit verkürzen wird. Stellen Sie jedoch sicher, dass kein Wasser verwendet wird, das über den normalen Spa Betriebstemperaturen liegt, das heißt, die 40°C nicht überschreitet. Wasser über 40°C schaltet die Heizung aus und wird als nicht sicher angesehen. Überprüfen Sie immer vor Gebrauch die Wassertemperatur im Whirlpool und beziehen Sie sich für detaillierte Informationen über die sichere Verwendung gegebenenfalls auf die Bedienungsanleitung.
- Aufrechterhalten einer Temperatur, wenn nicht in Betrieb: Ihr PureSpa ist wie jedes Haushaltsgerät oder ein fixer Whirlpool und für den Dauereinsatz können Sie eine bestimmte Temperatur wählen, die auch gehalten wird, wenn der Spa nicht in Gebrauch ist. Dies ermöglicht eine kürzere Aufheizzeit, wenn Sie den Pool wieder in Gebrauch nehmen. Zum Beispiel, die Aufrechterhaltung der Spa Wassertemperatur bei 30°C wird es Ihnen ermöglichen, 38°C in ca. 4 Stunden zu erreichen. Denken Sie daran, es ist nur eine Erhöhung der Wassertemperatur von ca. 2°C pro Stunde möglich (je nach Außentemperatur und Bedingungen), deshalb planen Sie Ihre Spa-Nutzung entsprechend.
HINWEIS: Das Spa verfügt über eine Sicherheitsabschaltfunktion, welche die Heizung nach 72 Stunden kontinuierlichen Heizens ausschaltet, wenn die eingestellte Temperatur nicht innerhalb dieser Frist erreicht wird. Kalte äußere Bedingungen können verhindern, dass die eingestellte Temperatur nicht erreicht wird. In diesem Fall wird sich Ihre Whirlpool Heizung abschalten und den Code "END" am Display anzeigen. Danach drücken Sie einfach die Taste Temperatureinstellungen, stellen die Temperatur zurück um die Heizung neu zu starten. Versuchen Sie eine niedrigere leicht erreichbare Temperatur für die gegebenen Bedingungen einzustellen, welche ein Neustarten der Heizung nach 72 Stunden nicht erfordert.
- Wassertemperatur während der Nutzung: Wenn Sie das Spa benutzen, wird die Wassertemperatur im Laufe der Zeit natürlich leicht sinken. Der erwartete Rückgang der Temperatur liegt bei ca. 1°C - 2°C pro Stunde, natürlich abhängig von den äußeren Bedingungen. Solange die Heizung mit einer eingestellten Temperatur eingeschaltet ist, beginnt die Erwärmung des Wassers automatisch, wenn die Temperatur um 1-2°C von der Solltemperatur sinkt.
Zum Beispiel: Wenn Ihre eingestellte Temperatur 39°C beträgt, wird sich die Heizung nicht einschalten, bis die Temperatur auf 37°C herunter fällt. Wenn Sie das Wasser vorher schon wieder erwärmen möchten, können Sie die Heizung einfach erneut Aus- und dann wieder Einschalten um Ihre bevorzugte Temperatur zu starten.

SPA ABDECKUNG:

- Die Abdeckung ist ein wichtiger Bestandteil des Spa, was das Aufheizen des Wassers und Halten der Temperatur, wenn das Whirlpool nicht in Gebrauch ist, betrifft. Darüber hinaus ist sie ein wesentliches Sicherheitselement zur Verhinderung des unberechtigten Zuganges zum Spa, besonders von Kindern.
- Beachten Sie bitte, dass die Befestigungsschnallen der Abdeckung Schnallen zur Verriegelung sind. Zwei Schlüssel werden zusätzlich zum Handbuch und anderem Zubehör in der Verpackung mitgeliefert. Jede Schnalle ist mit "gesperrt" und "entsperrt" Symbolen für die einfache Bedienung markiert. Stecken Sie den Schlüssel einfach in den Schlitz der Schnalle und drehen Sie ihn in die entsprechende Position um diese zu sperren oder zu entsperren.
- Um die Sicherheit vor unbefugtem Zugriff zu garantieren, geben Sie immer die Abdeckung auf den Whirlpool, wenn sich dieser nicht in Gebrauch befindet und verriegeln Sie alle Schnallen. Bewahren Sie die Schlüssel immer unerreichbar für Kinder auf.
- Falls Sie die Schlüssel verlegen, können Sie jede ähnliche Größe von Schraubenzieher verwenden um die Schnallen zu sperren oder entsperren.

HEBEN SIE DIESE BEDIENUNGSANLEITUNG AUF

LEGGERE PRIMA DI UTILIZZARE IL PRODOTTO!

Nota: Questa Guida Rapida fornisce suggerimenti importanti e utili prima di iniziare a montare la SPA. Tuttavia, essa non affronta tutti gli aspetti di installazione e d'uso della SPA, ed è comunque necessario leggere, comprendere e seguire il Manuale di Istruzioni per una corretta installazione, una corretta manutenzione e un utilizzo sicuro del vostro prodotto.

- Alimentazione: questo apparecchio necessita di una potenza minima di 13 Amp. La maggior parte dei circuiti domestici vanno da 13 a 16 Amp. In caso di cortocircuiti, controllare che altri apparecchi che impiegano carichi significativi di energia siano collegati allo stesso circuito della spa. Evitare di collegare l'unità alla presa di corrente utilizzando prolunghe. Svolgere il cavo prima dell'uso. Non posizionare la spina su materiali combustibili.
- Riscaldamento dell'acqua: quando in corrette condizioni di installazione e funzionamento, il riscaldatore alzerà la temperatura dell'acqua di 2°C all'ora POSTO CHE la spa sia correttamente posizionata in condizioni idonee. A seconda della temperatura iniziale dell'acqua nella spa e dell'aria esterna, potrebbe essere necessario qualche minuto per il riscaldamento. Se la temperatura iniziale dell'acqua è di 22°C e si desidera alzarla di 16°C fino a 38°C, il tempo di riscaldamento sarà così calcolato: $16^{\circ}\text{C}/2^{\circ}\text{C}$ all'ora = 8 ore. Per un utilizzo a sessioni ravvicinate il tempo di riscaldamento può essere accorciato mantenendo una temperatura di standby nella spa (fare riferimento alla sezione TEMPERATURA RISCALDAMENTO E ACQUA). Assicurarsi di coprire la spa quando non in uso.
- RCD: questo prodotto è dotato di RCD situato sul terminale del cavo di alimentazione. Il RCD deve essere controllato prima di ogni utilizzo. NON utilizzare la spa se il RCD non funziona correttamente (Consultare il manuale utente per le istruzioni relative al collaudo dell'interruttore differenziale).
- Cartuccia filtro: mantenere l'acqua della spa pulita e igienizzata per allungare la vita della cartuccia filtro. Fare riferimento al manuale di istruzioni per informazioni dettagliate sull'equilibrio dell'acqua e le modalità chimiche di pulizia.

APERTURA E GONFIAGGIO DELLA SPA:

- Quando si apre la SPA per la prima volta, è possibile sentire odore di plastica ma è normale per un prodotto nuovo. Si raccomanda quindi di gonfiare il prodotto e lasciarlo all'aperto per un giorno per favorire l'eliminazione dell'odore prima di procedere a riempire la SPA.
- Stendere il telo a terra con le bolle verso il basso sull'area precedentemente pulita su cui si intende montare la SPA.
- Per gonfiare la SPA, familiarizzare con la valvola a molla presente sulla vasca e la bocchetta di gonfiaggio sull'unità di controllo per assicurare un gonfiaggio corretto e veloce.

Bocchette di gonfiaggio:

- L'estremità più grande del tubo di gonfiaggio si attacca alla bocchetta in uscita dell'aria nella parte posteriore della base (vedere il manuale di istruzioni per i disegni e per ulteriori dettagli).
- Per fissare il tubo di gonfiaggio all'apertura di uscita dell'aria, sollevare il coperchio laterale della base di controllo per accedere all'uscita di gonfiaggio del compressore. Tirare la linguetta per aprire la copertura, inserire l'adattatore per tubo con tubo e chiudere nuovamente la linguetta per bloccare l'adattatore per tubo in posizione.
- Al termine del gonfiaggio, aprire la linguetta, estrarre il tubo di gonfiaggio e fissare nuovamente la linguetta sul compressore.

NOTE: per evitare un gonfiaggio eccessivo, è presente un dispositivo che farà sfiatare l'aria in eccesso dall'uscita posta sulla base della spa. Ciò è normale.

valvola di gonfiaggio con perno a molla:

- Subito dopo la rimozione del tappino della valvola, osservare il perno a molla al centro della valvola. Per il gonfiaggio, il perno a molla deve essere in posizione sollevata (posizione di chiusura della valvola) in modo che la pressione dell'aria della pompa spinga l'aria attraverso la valvola durante il gonfiaggio. Controllare il perno della valvola e assicurarsi che sia in alto o comunque in posizione sollevata prima di iniziare il gonfiaggio.
- Il perno può essere schiacciato e bloccato in posizione rientrata premendo e ruotando di 90 ° in senso orario con il dito - questa è la posizione di apertura della valvola utilizzata per lo sgonfiaggio che permette all'aria di uscire liberamente.

CONSERVARE QUESTE ISTRUZIONI

- Per collegare correttamente il beccuccio di gonfiaggio del tubo (l'estremità più piccola del tubo), spingerlo nella valvola e ruotarlo in senso orario finché non si blocca con la valvola (si può sentire uno scatto). Per rimuovere il beccuccio dopo il gonfiaggio, ruotarlo in senso antiorario e estrarlo dalla valvola.
- Una volta che la vasca è stata correttamente gonfiata, assicurarsi di chiudere il tappo della valvola per una corretta chiusura ermetica.

RISCALDATORE E TEMPERATURA DELL'ACQUA:

- Riempire con acqua già calda: è possibile utilizzare l'acqua riscaldata per riempire la SPA, riducendo così il tempo di riscaldamento iniziale. Tuttavia, assicurarsi di non utilizzare acqua superiore alle normali temperature tipiche dei centri termali dove l'acqua non è mai superiore ai 40 ° C. Se la temperatura dell'acqua è oltre i 40 ° C, l'unità di riscaldamento si spegne e non è considerato sicuro usare il prodotto.. Controllare sempre la temperatura dell'acqua nella vasca prima di utilizzare il prodotto e fare riferimento al manuale per informazioni dettagliate sull'uso in sicurezza.
- Mantenere la temperatura dell'acqua al minimo: la SPA è come un qualsiasi elettrodomestico o centro benessere e per un uso continuo nel tempo si può scegliere di impostare una certa temperatura costante quando il prodotto non è in uso. Questo permetterà di riscaldare l'acqua in un tempo minore appena si decide di usare il prodotto. Per esempio, mantenendo la temperatura dell'acqua a 30 ° C, si possono raggiungere i 38 ° C in circa 4 ore. Ricordate, l'aumento della temperatura dell'acqua è di circa 2 ° C all'ora (può variare a seconda della temperatura e delle condizioni esterne), in modo da pianificare l'uso della vostra SPA come meglio credete.
NOTA: La Spa dispone di una funzione di sicurezza di spegnimento che spegne l'impianto di riscaldamento dopo 72 ore di riscaldamento continuo, se la temperatura impostata non viene raggiunta entro tale termine. Ciò può avvenire a causa di condizioni esterne che potrebbero impedire l'innalzamento della temperatura al livello desiderato. In questo caso il vostro impianto di riscaldamento si spegne e visualizza il codice "END"; per riavviare l'unità di riscaldamento premere il pulsante di regolazione della temperatura e regolare di nuovo la temperatura. Fare una prova selezionando una temperatura più bassa, facilmente raggiungibile con le condizioni esterne e che non richiede di riavviare l'unità di riscaldamento dopo 72 ore.
- Temperatura dell'acqua durante l'utilizzo: quando si utilizza la SPA, la temperatura dell'acqua tende a ridursi leggermente nel tempo. La diminuzione di temperatura prevista può essere compresa tra 1 ° C e 2 ° C all'ora a seconda delle condizioni esterne. Finché l'unità di riscaldamento viene accesa con una temperatura impostata, il prodotto riscalderà automaticamente l'acqua quando la temperatura scenderà di 1-2 ° C rispetto ai gradi impostati. Esempio: se la temperatura impostata è di 39 ° C, il riscaldatore non si accende fino a quando la temperatura scende a 37 ° C. Se vi venisse voglia di riscaldare prima, è sufficiente resettare il riscaldatore spegnendolo e re-impostandolo per raggiungere la temperatura desiderata.

COPERTURA SPA:

- La copertura è una parte importante della SPA in quanto è fondamentale per il riscaldamento dell'acqua e per il mantenimento della temperatura quando la SPA non è in uso. Inoltre, è un elemento di sicurezza fondamentale per prevenire l'accesso non autorizzato al prodotto soprattutto dei bambini.
- Si noti che i laccetti di fissaggio della copertura sono laccetti di chiusura. Nel sacchetto di plastica con il manuale e altri accessori ci sono in dotazione due tasti Ogni laccetto è contrassegnato con i simboli "bloccato" e "sbloccato" per un facile utilizzo: mettere la chiave nella fessura sul laccetto e girarla nella posizione appropriata rispettivamente per bloccare o sbloccare il laccetto.
- Per garantire la sicurezza dall'accesso non autorizzato, mettere sempre la copertura quando la SPA non è in uso e bloccare tutte le fibbie. Tenere sempre le chiavi fuori dalla portata dei bambini.
- In caso di smarrimento delle chiavi, è possibile utilizzare qualsiasi cacciavite piatto di dimensioni simili per bloccare o sbloccare i laccetti.

CONSERVARE QUESTE ISTRUZIONI

LEES ALVORENS U BEGINT!

Let op: Dit informatieblad bevat belangrijke en bruikbare tips betreft het opzetten en in gebruik nemen van uw SPA. Echter bevat het niet alle benodigde informatie betreft het opzetten en gebruiken van uw SPA, u dient nog steeds de handleiding aandachtig te lezen en op te volgen.

- **Voeding:** Dit product heeft minimum 13 Amp nodig. De meeste stroomkringen in woningen hebben 13 tot 16 Amp. Als de leidingbeveiligingsschakelaar wordt geactiveerd, controleer of er zich geen andere apparaten of een andere grote belasting op dezelfde stroomkring als de spa bevinden. Gebruik geen verlengkabel snoer. Wikkel het snoer af voor gebruik. Leg de stekker nooit op een brandbaar materiaal.
- **Water opwarmen:** Dit verwarmingstoestel zal, bij een juiste instelling en werking, de watertemperatuur met 2°C per uur verhogen MITS het deksel juist is geplaatst. Afhankelijk van de begintemperatuur van het water in de spa en de luchttemperatuur van de omgeving kan het enige tijd duren voordat het water is opgewarmd. Als de begintemperatuur van uw leidingwater 22°C is en u wilt het met 16° C verhogen tot 38°C, is de opwarmtijd 16°C/2°C per uur = 8 uur. Voor een opeenvolgend gebruik, kan de opwarmtijd worden verkort door een bepaalde temperatuur van het water in de spa te behouden (zie de sectie OPWARMEN EN WATERTEMPERATUUR). Plaats altijd het deksel op de spa wanneer niet in gebruik.
- **RCD (stroomonderbreker):** Dit product is voorzien van een RCD die zich op het einde van het snoer bevindt. Test de RCD voor elk gebruik. Gebruik de spa NIET als de RCD niet juist werkt. (Raadpleeg de gebruikershandleiding voor de juiste testprocedure van de differentieelschakelaar (RCD)).
- **Filterpatroon:** Houd het water in de spa goed schoon voor een langere levensduur van de patroon. Zie de gebruiksaanwijzing voor gedetailleerde informatie over de chemische eigenschappen en het evenwicht van het water in de spa.

HET UITVOUWEN EN OPBLAZEN VAN UW SPA:

- Tijdens het de eerste keer uitvouwen van de SPA is de geur van het materiaal waarschijnlijk merkbaar, dit is normaal bij een dergelijk product dat nieuw uit de doos komt. Om die reden is het aan te raden de SPA op te blazen en een nacht zonder water buiten te laten staan zodat het materiaal de kans heeft om de sterke geur te verliezen.
- Het grondzeil dient met de luchtbubbels naar beneden neergelegd te worden.
- Bekijk alvorens het installeren het ventiel op de SPA en de uitlaat van de controle unit aandachtig om ervoor te zorgen dat de installatie soepel verloopt.

Tips bij het opblazen:

- Het grotere uiteinde van de opblaas slang wordt geplaatst op de luchtuitlaat aan de achterzijde van de unit (zie handleiding voor illustratie en details).
- Om de opblaas slang aan de luchtuitlaat te bevestigen, klap de zijkap van de regeleenheid omhoog om de opblaasuitlaat van de luchtblazer te onthullen. Trek de grendel uit om de afdekkap te openen, breng de slangadapter met de slang aan en maak de grendel vast aan de slangadapter om het stevig vast te zetten.
- Wanneer volledig opgeblazen, maak de grendel los, trek de opblaas slang uit en zet de grendel opnieuw op de uitlaat vast.

OPMERKING: Om overspanning te vermijden zal er tijdens het opblazen lucht uit de onderste luchtuitlaat van de regeleenheid worden vrijgegeven. Dit is normaal.

Tips betreft het spring ventiel:

- Denk er bij het verwijderen van de ventieldop aan dat er een springveer in het midden van het ventiel zit. Indien u start met opblazen zou de springveer omhoog moeten staan daar de druk van de pomp zorgt dat de lucht dor het ventiel geblazen wordt. Controleer alvorens het opblazen of de springveer omhoog staat.
- De springveer kan vastgezet worden door deze ingedrukt te houden en 90o met uw vinger met de klok mee te draaien, op deze manier wordt het ventiel open gezet en kan er lucht uit gelaten worden.

BEWAAR DEZE HANDLEIDING GOED

- Om de luchtslang met opzetstuk (smallere uiteinde van de slang) correct aan te sluiten dient u deze in het ventiel te duwen en met de klok mee te draaien totdat deze vast zit ("klik" geluid is mogelijk). Om het opzetstuk te verwijderen dient u deze tegen de klok in te draaien, hierna kan het opzetstuk uit het ventiel gehaald worden.
- Zodra de SPA correct is opgeblazen dient u ervoor te zorgen dat het ventiel goed gesloten wordt met de afdichtingsdop.

VERWARMEN EN WATERTEMPERATUUR:

- Vullen met warm water: het is mogelijk de SPA met warm water te vullen om de verwarmingstijd in te korten. Houdt er wel rekening mee dat het water dat u gebruikt om te vullen nooit hoger mag zijn dan de maximale temperatuur van 40°C die de SPA verwarmt. Water warmer dan 40°C zorgt ervoor dat vanwege veiligheidsredenen het verwarmingssysteem wordt uitgeschakeld. Controleer altijd alvorens u gebruik gaat maken van de SPA of de watertemperatuur veilig is (zie handleiding voor details).
- Het zorgen voor de ideale watertemperatuur: het is verstandig bij regelmatig gebruik te zorgen voor een constante watertemperatuur om de verwarmingstijd te verkorten. Als u b.v. de watertemperatuur op 30°C heeft staan duurt het ongeveer 4 uur voordat de temperatuur gestegen is tot 38°C. Denk dus altijd aan de verwarmingstijd van 2°C per uur (afhankelijk van de buitentemperatuur) alvorens u de SPA gaat gebruiken.
Let op: de SPA is voorzien van een beveiliging welke ervoor zorgt dat het verwarmingssysteem afslaat indien de ingestelde temperatuur niet bereikt is na 72 uur continue verwarming. Dit kan voorkomen indien de buitentemperatuur dusdanig laag is dat dit het behalen van de ingestelde temperatuur tegengaat. Indien dit zich voordoet zal het verwarmingssysteem uitgaan en ziet u "END" in het display staan. U kunt nu de gewenste temperatuur opnieuw instellen, het is aan te raden een voor lagere watertemperatuur te kiezen.
- De watertemperatuur tijdens gebruik: Het is normaal dat de temperatuur langzaam daalt tijdens het gebruik van de SPA. De temperatuur afhankelijk van de buitentemperatuur zal tussen de 1°C en 2°C per uur dalen. Zolang het verwarmingssysteem in werking is en er een temperatuur ingesteld is, zal deze automatisch gaan verwarmen zodra de watertemperatuur 1-2°C onder de ingestelde temperatuur komt.
Voorbeeld: indien de ingestelde temperatuur 39°C is, zal het verwarmingssysteem niet aanslaan totdat het water een temperatuur van 37°C bereikt. Mocht u willen dat het verwarmingssysteem sneller weer in werking treedt dan kunt u deze resetten en wederom de gewenste temperatuur instellen.

AFDEKZEIL:

- Het afdekzeil is een uiterst belangrijk onderdeel van de SPA. Het afdekzeil is niet alleen belangrijk i.v.m. de watertemperatuur, ook zorgt deze voor de veiligheid tijdens het niet gebruiken van de SPA.
- De gespen aan het afdekzeil zijn bedoeld om het zeil op slot te zetten. Er worden twee sleutels meegeleverd in de plastic zak met de handleiding en andere accessoires. Om het gebruik te vergemakkelijken zijn alle gespen voorzien van "dicht" en "open" symbolen; plaats de sleutel in het slot van de gesp en draai deze de juiste richting in om op of van slot te zetten.
- Om veiligheid te waarborgen dient u er altijd voor te zorgen dat het afdekzeil gebruikt en afgesloten wordt indien de SPA niet in gebruik is. Houdt de sleutels buiten bereik van kinderen.
- Indien u de sleutels kwijt geraakt bent kunt u een platkop schroevendraaier gebruiken om de gespen te openen of te sluiten.

BEWAAR DEZE HANDLEIDING GOED

LEIA ANTES DE COMEÇAR!

NOTA: Este guia de início rápido fornece dicas importantes e úteis antes de iniciar a instalação do seu Spa. No entanto, não aborda todos os aspectos da instalação e uso do Spa, e você ainda é obrigado a ler, entender e seguir o manual do proprietário para a instalação, manutenção e uso seguro de seu Spa.

- Alimentação elétrica: Este aparelho necessita de um mínimo de 13 Amperes. A maioria dos circuitos domésticos são de 13 a 16 Amperes. Se o disjuntor disparar, verificar que não estejam ligados outros aparelhos de grande consumo no mesmo circuito ao que está ligado o spa. Não use extensões elétricas. Desenrole o fio antes da utilização. Nunca coloque a ficha em materiais combustíveis.
- Aquecimento da água: Este aquecedor, quando corretamente instalado e em funcionamento elevará a temperatura da água em 2 °C por hora desde que a cobertura do spa esteja devidamente colocada. Dependendo da temperatura inicial da água do spa e da temperatura do ar exterior, pode demorar algum tempo a aquecer. Se a temperatura inicial da água da torneira for de 22 °C e se deseja elevá-la em 16 °C para atingir os 38 °C, o tempo de aquecimento será de 16 a dividir por 2 °C por hora = 8 horas. Para as utilizações posteriores o tempo de aquecimento pode ser encurtado mantendo a temperatura da água inerte (consultar a secção AQUECIMENTO E TEMPERATURA DA ÁGUA). Não se esquecer de manter o spa tapado com a cobertura quando não estiver a ser usado.
- Disjuntor diferencial (RCD): Este aparelho está equipado com um disjuntor diferencial localizado na extremidade do cabo elétrico. O disjuntor diferencial tem de ser testado antes de cada utilização. NÃO utilizar o spa se o disjuntor diferencial não funcionar adequadamente. (Consulte o manual do utilizador quanto a instruções do teste adequado do DCR).
- Cartucho do filtro: Conservar a água do spa adequadamente higiénica e desinfetada para aumentar a vida útil do cartucho. Consultar o manual de utilização para obter informações mais detalhadas sobre as características químicas e estabilidade da água no spa.

DESDOBRANDO E INFLANDO SEU SPA:

- Quando desdobrar a lona inflável do Spa você pode perceber o cheiro do material, que é normal para um produto novo quando fora da caixa. Portanto, é recomendável inflar o produto e deixá-lo ao ar livre por um dia para permitir que o cheiro do produto novo seja dissipado antes de encher o Spa com água.
- Abrir a proteção de fundo com as bolhas voltada para baixo sobre a área limpa onde você pretende montar o seu Spa.
- Para a inflação o Spa, familiarize-se com a mola na válvula de ar na lona do Spa e com o bico da mangueira da unidade de controle para assegurar que o produto seja inflado de forma rápida e adequada.

Dicas para o bico da mangueira de inflar:

- A extremidade maior da mangueira de inflar conecta à saída de ar na parte de trás na base da unidade de controle (ver o manual do proprietário para os desenhos e detalhes adicionais).
- Para fixar a mangueira de enchimento na saída do ar, vire a cobertura lateral da base de controle para encontrar a saída de enchimento do soprador de ar. Puxe o trinco para fora para abrir a cobertura, insira o adaptador da mangueira com a mangueira e volte a fixar o trinco no adaptador da mangueira para o fixar no respetivo lugar.
- Quando o enchimento terminar, liberte o trinco, puxe a mangueira de enchimento para fora e fixe o trinco de novo na saída.

NOTA: Para evitar uma eventual sobreinsuflação durante a insuflação, algum ar escapará através da saída das bolhas de ar na parte inferior da base de controle. Isto é perfeitamente normal.

Dicas para a mola da válvula:

- Depois de retirar a tampa da válvula, observe o pino com a mola no centro da válvula. Para inflar, a mola do pino deve estar na posição para cima / levantado (posição de fechamento da válvula), de modo que a pressão do ar da bomba empurrará o ar através da válvula durante o enchimento da lona. Verifique o pino de válvula e assegure-se que esteja para cima / posição levantada antes de iniciar o enchimento da lona.
- O pino pode ser pressionado e bloqueado na posição para baixo, pressionando e girando-o em 90 ° no sentido horário com o dedo - esta é a posição aberta da válvula que permite que o ar flua livremente para fora e que é utilizado para desinflar.

GUARDE ESTAS INSTRUÇÕES

- Para fixar corretamente o bocal da mangueira de inflar (a extremidade menor da mangueira), empurre-o para dentro da válvula e gire no sentido horário até encaixar com a válvula (você irá ouvir um clique). Para remover o bico, gire-o em sentido anti-horário e puxe-o para fora da válvula.
- Uma vez que a lona do Spa esteja está devidamente inflada, certifique-se de fechar a tampa da válvula para uma vedação hermética adequada.

AQUECIMENTO E TEMPERATURA DA ÁGUA:

- Enchendo com água aquecida: Você pode usar água aquecida para preencher o Spa, reduzindo o tempo de aquecimento inicial. No entanto, certifique-se de não usar água superior as temperaturas de funcionamento normais do Spa que não deve ultrapassar os 40 ° C. Água acima de 40 ° C irá desligar a unidade de aquecimento e não é considerado seguro. Verifique sempre a temperatura da água em seu Spa antes de usar e consulte o manual do proprietário para obter informações detalhadas sobre a utilização segura.
- Mantendo a temperatura da água ociosa: Seu Spa é como qualquer eletrodoméstico ou um Spa fixo, e para uso contínuo você pode optar por definir uma determinada temperatura ociosa para ser mantida no Spa quando não estiver em uso. Isso permitirá um mais curto tempo de aquecimento para quando você decidir usá-lo. Por exemplo, mantendo a temperatura da água termal a 30 ° C irá permitir atingir 38 ° C em cerca de 4 horas. Lembre-se, o aumento da temperatura da água é de cerca de 2 ° C por hora de aquecimento (pode variar dependendo da temperatura e condições externas), então planeje o uso do seu Spa.
NOTE: O Spa tem uma característica de desligamento segura que irá desligar a unidade de aquecimento após 72 horas de aquecimento contínuo, se a temperatura do conjunto não for alcançada dentro desse período. Isto pode ocorrer em condições externas de frio que pode impedir que a temperatura do conjunto de ser alcançada. Nesse caso, a unidade de aquecimento do Spa irá desligar e exibir o código "END", exigindo que o botão de ajuste de temperatura seja apertado e que a temperatura seja redefinida para reiniciar a unidade de aquecimento. Tente uma temperatura mais baixa para as condições dadas, na qual não irá exigir o reinício da unidade de aquecimento após 72 horas.
- A temperatura da água durante o uso: Quando você estiver usando o Spa, a temperatura da água irá diminuir de forma natural ao longo do tempo. A diminuição de temperatura esperada pode ser em qualquer lugar entre 1 ° C e 2 ° C por hora, dependendo das condições externas. Enquanto a unidade de aquecimento estiver ligada com uma temperatura definida, o aquecedor irá iniciar o aquecimento da água automaticamente quando a temperatura da água cair 1-2 ° C da temperatura desejada.
Exemplo: Se a temperatura definida é de 39 ° C, o aquecedor não virá até que a temperatura caia para 37 ° C. Caso você deseje elevar a temperatura de volta mais cedo, você pode simplesmente redefinir o aquecedor desligando-o e iniciando o aquecimento de volta para a sua temperatura preferida.

CAPA DO SPA:

- A capa é uma parte importante do seu Spa, uma vez que é crucial para aquecer a água e manter a temperatura quando Spa não está em uso. Além disso, é um elemento de segurança importante para prevenir o acesso não autorizado ao Spa, especialmente pelas crianças.
- Note-se que os fechos de fixação da tampa são fivelas. Duas chaves são fornecidas no saco plástico, com os acessórios e outros manuais. Cada fivela é marcada com símbolos "bloqueado" e "desbloqueado" para uma fácil utilização: coloque a chave na abertura da fivela e gire-a para a posição bloquear ou desbloquear o fecho.
- Para garantir a segurança de acesso não autorizado, sempre colocar a tampa no Spa quando não estiver em uso e tranque todas as fivelas. Sempre mantenha as chaves fora do alcance das crianças.
- No caso de você perder as chaves, você pode usar qualquer chave de fenda de tamanho semelhante para bloquear ou desbloquear as fivelas.

GUARDE ESTAS INSTRUÇÕES

LÆS DETTE FØR DU BEGYNDER!

BEMÆRK: Denne lynvejledning giver dig vigtige og nyttige tips, før du begynder opsætningen af dit spabad. Den dækker dog ikke alle aspekter af spabadets installering og brug, så du bør stadig læse, forstå og følge betjeningsvejledningen for lære mere om korrekt installering, vedligeholdelse og sikker brug af dit spabad.

- **Strømforsyning:** Dette produkt kræver et minimum af 13 ampere. De fleste husholdningskredsløb er på mellem 13 og 16 ampere. Hvis relæet går, bør du sikre dig, at der ikke er tilsluttet andre apparater eller andre store belastninger til det samme kredsløb som spabadet. Skal du undgå at anvende forlængerledninger. Rul ledningen ud før brug. Stikket må aldrig placeres på brændbare materialer.
- **Vandopvarmning:** Hvis det er korrekt indstillet, vil opvarmningssystemet hæve vandtemperaturen med 2 °C i timen, FORUDSAT at spabadets dæksel sidder rigtigt på plads. Afhængigt af starttemperaturen på vandet i spabadet og den ambiente lufttemperatur, kan det tage nogen tid at varme vandet op. Hvis vandets starttemperatur er 22 °C og du ønsker at hæve den med 16 °C til 38 °C, vil opvarmningstiden være 16 °C / 2 °C per time = 8 timer. Efterfølgende kan opvarmningstiden forkortes ved at opretholde en vente-temperatur i spabadet (se afsnittet om OPVARMNING OG VANDTEMPERATUR). Husk at lægge dækslet på spabadet, når det ikke er i brug.
- **RCD:** Dette produkt er forsynet med et RCD-fejlstrømsrelæ placeret for enden af ledningen. Dette RCD-relæ skal testes før hver brug. Brug ALDRIG spabadet, hvis HFI-relæet ikke fungerer korrekt. (Se brugsanvisning for korrekt test af RCD-instruktioner).
- **Filterpatron:** Filterpatronens levetid kan forlænges ved at holde spavandet ordentligt desinficeret. Der henvises til brugervejledningen for detaljeret information om spavand kemi og balance.

UDFOLDNING OG OPPUMPNING AF DIT SPABAD:

- Når du folder det oppustelige spabad ud, vil du måske bemærke en lugt af plastik. Det er helt normalt for et nyt produkt, der lige er taget ud af pakningen. Det anbefales derfor at puste badet op og lade det stå til afluftning udendørs i en dags tid for give lugten tid til at fordamp, før du fylder spabadet med vand.
- Spred underlaget, med boblerne nedad, over det ryddede område, hvor du vil opsætte dit spabad.
- Før du puster spabadet op, bør du forstå, hvordan spabadets fjederbelastede luftventil og kontrolpanelets oppustningsudgang virker for at sikre hurtig og korrekt oppustning.

Tips vedrørende oppustningsudgangen:

- Den største ende på ventilslangen tilsluttes luftudtaget på bagsiden af kontrolenheden (se betjeningsvejledningen for tegninger og yderligere detaljer).
- For at fastgøre inflatorslangen til luftudtaget skal du dreje siden af betjeningsbasens dæksel op for at vise luftblæserens inflationsudtag. Træk låsen ud for at åbne dækslet, indsæt slangeadapteren med en slange og sæt låsen fast på slangeadapteren for at sætte den sikkert på plads.
- Når inflationen er færdig, skal du løsne låsen, trække inflatorslangen ud og fastgøre låsen på udtaget igen.
BEMÆRK: For at undgå overoppumpning, kan der under oppustningen sive lidt luft ud via kontrolpanelets luftudgang. Dette er helt normalt.

Tips vedrørende den fjederbelastede luftventil:

- Efter at have fjernet ventilhætten, skal du undersøge den fjederbelastede stift i midten af ventilen. Før oppustning, skal stiften være oppe / i en hævet position (ventilen er lukket), da luftrykket fra pumpen vil presse luft gennem ventilen under oppustningen. Kontrollér ventilstiften for at sørge for, at den er oppe / i en hævet position, før oppustningen begynder.
- Stiften kan presses ned og låses i denne forsænkede position ved at trykke den ned med en finger og dreje den 90 ° med uret - dette position, der åbner ventilen og tillader luft at strømme frit ud, bruges til luftudsugning.

GEM DENNE VEJLEDNING

- For at fastgøre slangens oppustningsdysse (den tyndere af slangen) rigtigt, skal du skubbe den ind i ventilen og dreje den med uret, indtil den låses sammen med ventilen (du vil høre et klik). Efter oppustningen, fjerner du dysen ved at dreje den mod uret og trække den ud af ventilen.
- Når karret er korrekt oppumpet, skal du sørge for at skrue ventilhætten på igen for at sikre en lufttæt forsegling.

OPVARMNING OG VANDTEMPERATUR:

- Påfyldning med opvarmet vand: Du kan bruge opvarmet vand til at fylde spabadet, hvilket vil forkorte den indledende opvarmningsstid. Du må dog ikke bruge vand, der er varmere end spabadets normale driftstemperaturer, der ikke overstiger 40 °C. Vand der er varmere end 40 °C vil slukke for opvarmningssystemet og er ikke betragtet som sikkert. Du skal altid tjekke spabadets vandtemperatur før brug, og vi henviser til betjeningsvejledningen for detaljerede oplysninger om sikker brug.
- Opretholdelse af vandtemperaturen: Dit PureSpa er ligesom enhver andet husholdningsapparat eller et fast spabad. Bruger du det derfor regelmæssigt, kan du vælge at indstille spabadet til at opretholde en bestemt ventetemperatur, når det ikke er i brug. Dette vil give en kortere opvarmningstid, når du beslutter dig for at bruge det. For eksempel, hvis du opretholder en vandtemperatur i spabadet på 30 °C, vil du nå op til de 38 °C på omkring 4 timer. Husk, at vandets temperatur stiger med cirka 2 °C i timen under opvarmning (dette kan dog variere afhængigt af udetemperaturen og andre vilkår), så planlæg dit bad i overensstemmelse hermed. **BEMÆRK:** Dit spabad har en sikkerhedsfunktion, der slukker opvarmningssystemet efter 72 timers uafbrudt opvarmning, hvis den indstillede temperatur ikke er nået inden for denne periode. Dette kan forekomme i kolde eksterne forhold, der kan forhindre den indstillede temperatur i at blive nået. Sulle dette ske, vil opvarmningssystemet slukkes og koden "END" vises på displayet, hvilket nødvendiggør at du skal trykke på temperaturindstillingsknappen og genindstille temperaturen for at genstarte opvarmningssystemet. Forsøg at bruge en lavere, mere tilgængelig, temperatur for de givne betingelser, som ikke vil kræve en genstart af opvarmningssystemet efter 72 timer.
- Vand temperatur under brug: Når du bruger spabadet, falder vandtemperaturen naturligvis lidt efter lidt. Det forventede temperaturfaldet vil være mellem 1 °C og 2 °C i timen afhængig af eksterne forhold. Så længe opvarmningssystemet er tændt med en forudbestemt temperatur, vil det begynde at opvarme vandet automatisk, når vandtemperaturen falder til 1-2 °C under den indstillede temperatur.
Eksempel: Hvis du har sat vandtemperaturen til 39 °C, vil varmesystemet ikke starte før temperaturen er faldet til 37 °C. Ønsker du at varme vandet op igen lidt hurtigere, skal du blot genindstille varmeopvarmningssystemet ved at slukke det og tænde det igen for at opnå din foretrukne temperatur.

SPABADETS DÆKSEL:

- Dækslet er en vigtig del af dit spabad, da det spiller en afgørende rolle i at opvarme vandet og i at opretholde temperaturen, når badet ikke er i brug. Derudover er det en vigtig sikkerhedsforanstaltning til forebyggelse af uautoriseret adgang til spabadet, især børns tilgang dertil.
- Bemærk at dækslets hængsler er låsehængsler. Plastikposen med betjeningsvejledningen og andet tilbehør indeholder også to nøgler. Hvert hængsel er markeret med "låst" og "åben" symboler for lette betjeningen: Sætte nøglen i hængslets nøglehul og drej den til den ønskede position for henholdsvis at låse eller åbne hængslet.
- For øget sikkerhed mod uautoriseret adgang, skal du altid lægge dækslet på, når spabadet ikke er i brug, og låse alle hængsler. Nøglerne bør altid holdes utilgængelige for børn.
- Hvis du forlægger nøglerne, kan du bruge en flad skruetrækker af lignende størrelse til at åbne eller låse hængslerne.

GEM DENNE VEJLEDNING

PRZECZYTAJ ZANIM ROZPOCZNIESZ!

Polish

244
IO

UWAGA: Niniejsza podręczna instrukcja uruchamiania produktu zawiera ważne i przydatne wskazówki przed przystąpieniem do instalacji basenu spa. Nie obejmuje jednak wszystkich aspektów związanych z instalacją i użytkowaniem basenu spa co oznacza, że użytkownik nadal zobowiązany jest przeczytać ze zrozumieniem instrukcję obsługi w celu zapewnienia poprawnej instalacji, konserwacji i bezpiecznego użytkowania basenu spa.

- Zasilanie: Ten produkt wymaga zasilania prądem o natężeniu co najmniej 13 amperów. W większości instalacji domowych natężenie prądu wynosi od 13 do 16 amperów. Jeżeli zadziała bezpiecznik, prosimy sprawdzić, czy do tego samego. Przed użyciem należy rozwinąć przewód zasilający. Nigdy nie należy umieszczać wtyczki na materiałach łatwopalnych.
- Podgrzewanie wody: POD WARUNKIEM poprawnego umieszczenia pokrywy spa oraz właściwego skonfigurowania i umieszczenia urządzenia, pracujący grzejnik podnosi temperaturę wody o 2°C na godzinę. W zależności od temperatury początkowej wody w spa oraz temperatury powietrza na zewnątrz, nagrzewanie może zająć trochę czasu. Jeżeli temperatura początkowa wody wynosi 22°C, a użytkownik chce ją podnieść o 16°C do 38°C, wówczas czas podgrzewania wyniesie 16°C/2°C godzin, czyli = 8 godzin. Dalsze używanie funkcji grzania: czas grzania można skrócić przez utrzymywanie temperatury spoczynkowej spa (patrz część GRZANIE I TEMPERATURA WODY). Na czas nieużywania na basen spa należy położyć pokrywę.
- Wyłącznik różnicowoprądowy (RCD): Produkt jest wyposażony w wyłącznik różnicowoprądowy, który znajduje się z tyłu przewodu zasilającego. Przed użyciem wyłącznik różnicowoprądowy należy przetestować. Jeżeli wyłącznik nie działa właściwie, basen spa nie należy używać (Zalecenia dotyczące prawidłowego testowania wyłącznika różnicowoprądowego: patrz instrukcja obsługi).
- Wkład filtrujący: aby wydłużyć czas działania wkładu, wodę w spa należy odpowiednio dezynfekować. Szczegółowe informacje o procesach chemicznych wody w spa znaleźć można w instrukcji użytkownika.

ROZŁOŻENIE I NAPOMPOWANIE BASENU SPA:

- Po rozłożeniu nadmuchiwanego basenu spa możesz poczuć zapach, który jest normalny dla nowego produktu wyjętego z opakowania. Dlatego zaleca się przed napełnieniem basenu spa wodą napompowanie produktu i pozostawienie go na zewnątrz na jeden dzień w celu przewietrzenia i stopniowej utraty zapachu charakterystycznego dla nowego produktu.
- W oczyszczonym miejscu, w którym chcesz zainstalować basen spa, rozłóż płachtę spodnią tak, by bąbelki skierowane były ku dołowi.
- W celu napompowania basenu spa zapoznaj się z zaworem sprężynowym na spa oraz z wylotem na skrzynce sterowniczej w celu zapewnienia szybkiego i poprawnego nadmuchiwania basenu spa.

Wskazówki dotyczące wylotu do pompowania:

- Większy koniec węża inflacyjnego przyłącz do wylotu powietrza z tyłu jednostki kontrolnej (rysunki i więcej szczegółów podano w instrukcji obsługi).
- Aby zamocować wąż do pompowania do wylotu powietrza, należy odchylić boczną osłonę podstawy sterującej tak aby odsłonić wylot do pompowania dmuchawy powietrza. Należy wysunąć zatrzask, aby otworzyć osłonę, włożyć adapter węża z węzłem i ponownie założyć zatrzask adaptera węża, aby zamocować go na miejscu.
- Po zakończeniu pompowania należy odblokować zatrzask, wyciągnąć wąż do pompowania i zamocować zatrzask z powrotem na wylocie.

UWAGA: Aby nie dopuścić do zbyt mocnego napompowania, podczas pompowania część powietrza ucieka przez dolny wylot pęcherzykowy podstawy sterującej. Jest to normalne.

Wskazówki dotyczące zaworu sprężynowego:

- Po usunięciu nakrętki zaworu zauważysz w środku zaworu kołek sprężynujący. W czasie pompowania kołek powinien znajdować się w pozycji pionowej / uniesionej (zawór w położeniu zamkniętym), ponieważ ciśnienie powietrza z pompy będzie w czasie pompowania wypychać powietrze przez zawór. Przed rozpoczęciem pompowania sprawdź kołek sprężynujący i upewnij się, że znajduje się on w pozycji pionowej / uniesionej.
- Kołek można wcisnąć i zablokować w pozycji zagłębionej poprzez jego naciśnięcie palcem i obrót o 90° zgodnie z ruchem wskazówek zegara – jest to otwarte położenie zaworu, które pozwala na swobodny przepływ powietrza i które jest używane, żeby wypuścić powietrze.

ZACHOWAJ NINIEJSZĄ INSTRUKCJĘ

- W celu prawidłowego zamocowania dyszy węża (węższy koniec węża), wciśnij ją w zawór i przekręć zgodnie z ruchem wskazówek zegara, dopóki nie zablokuje się w zaworze (możesz usłyszeć kliknięcie). W celu usunięcia wentyla po zakończeniu pompowania przekręć go przeciwnie do ruchu wskazówek zegara i wyciągnij z zaworu.
- Po poprawnym napompowaniu basenu spa upewnij się, że szczelnie zamknąłeś nakrętkę zaworu.

PODGRZEWANIE I TEMPERATURA WODY:

- Napełnienie podgrzaną wodą: do napełnienia basenu spa możesz użyć podgrzanej wody, co skróci czas początkowego nagrzewania. Upewnij się jednak, że temperatura wody nie przekracza standardowej temperatury pracy basenu spa, to znaczy nie wyższej niż 40°C. Woda o temperaturze wyższej niż 40°C spowoduje wyłączenie urządzenia grzewczego, dopóki temperatura nie obniży się do bezpiecznego poziomu. Przed skorzystaniem z basenu spa zawsze sprawdzaj temperaturę wody i zapoznaj się ze szczegółowymi informacjami dotyczącymi bezpiecznego użytkowania podanymi w instrukcji obsługi.
- Utrzymanie stałej temperatury wody: podobnie jak w przypadku innych urządzeń gospodarstwa domowego lub montowanych na stałe basenów spa, w basenie Pure Spa możesz przy stałym użytkowaniu ustawić pewną stałą temperaturę, która będzie utrzymywana w basenie spa, kiedy nie jest on używany. Pozwoli to na skrócenie czasu nagrzewania, kiedy zdecydujesz się skorzystać ze spa. Na przykład utrzymanie temperatury wody w basenie spa na poziomie 30°C pozwoli na jej podgrzanie do temperatury 38°C w mniej więcej 4 godziny. Pamiętaj, że temperatura wody podnosi się o około 2°C na godzinę podgrzewania (wartość ta może być różna w zależności od temperatury powietrza na zewnątrz i innych warunków), więc planuj używanie spa uwzględniając powyższe.
UWAGA: Basen spa wyposażony jest w funkcję wyłącznika bezpieczeństwa, który wyłączy urządzenie nagrzewające po 72 godzinach ciągłego nagrzewania, jeśli ustawiona wartość temperatury nie zostanie w tym czasie osiągnięta. Może to nastąpić w chłodnym otoczeniu, które może uniemożliwić osiągnięcie ustawionej temperatury. W takim przypadku urządzenie nagrzewające basenu spa wyłączy się i wyświetli się komunikat "END", który wymaga wciśnięcia przycisku ustawienia temperatury w celu ponownego uruchomienia urządzenia nagrzewającego. Spróbuj ustawić niższą wartość temperatury osiągalną w danych warunkach, która nie będzie wymagała ponownego uruchomienia urządzenia nagrzewającego po 72 godzinach.
- Temperatura wody w czasie używania: w czasie korzystania z basenu spa temperatura wody obniży się w sposób naturalny w miarę upływu czasu. Oczekiwany spadek temperatury wynosić może między 1°C a 2°C na godzinę w zależności od warunków zewnętrznych. Jeśli urządzenie nagrzewające pozostaje włączone przy ustawionej wartości temperatury, będzie ono ogrzewać wodę automatycznie, kiedy jej temperatura spadnie o 1-2°C w stosunku do ustawionej temperatury.
Przykład: Jeśli ustawiona przez Ciebie temperatura wynosi 39°C, grzałka nie włączy się, dopóki temperatura nie spadnie do 37°C. Jeśli chcesz podgrzać ją wcześniej, możesz po prostu zrestartować grzałkę, wyłączając ją i włączając ponownie, żeby rozpocząć nagrzewanie do pożądanej temperatury.

POKRYWA SPA:

- Pokrywa jest ważną częścią basenu spa, ponieważ odgrywa kluczową rolę w nagrzewaniu wody i utrzymaniu temperatury, kiedy basen spa nie jest używany. Co więcej, jest ona istotnym elementem bezpieczeństwa, uniemożliwiającym nieuprawnionym osobom, a szczególnie dzieciom, dostęp do basenu spa.
- Zwróć uwagę, że klamry spinające służą jako zabezpieczenie. W plastikowej torebce dostarczane są dwa klucze, podręcznik i inne akcesoria. Każda klamra ma oznaczenia „zamknięte” i „otwarte” ułatwiające obsługę: umieść klucz w otworze klamry i przekręć go do odpowiedniej pozycji, żeby otworzyć lub zamknąć klamrę.
- Żeby uniemożliwić dostęp osobom nieupoważnionym, zawsze zakładaj na basen spa pokrywę, kiedy nie jest on używany i zamykaj wszystkie klamry. Zawsze przechowuj klucze w miejscu niedostępnym dla dzieci.
- Jeśli zgubisz klucze, w celu zamknięcia lub otwarcia klamer możesz użyć dowolnego płaskiego śrubokrętu o podobnym rozmiarze.

ZACHOWAJ NINIEJSZĄ INSTRUKCJĘ



ВНИМАТЕЛЬНО ПРОЧИТЕ ПЕРЕД ИСПОЛЬЗОВАНИЕМ!

Русский

244
IO

ПРИМЕЧАНИЕ: Данное краткое руководство пользователя содержит важные и полезные советы, с которыми необходимо ознакомиться до начала настройки спа-оборудования. Тем не менее, в руководстве не учтены все аспекты установки и использования спа; однако, в любом случае необходимо прочитать и понять инструкции по эксплуатации и следовать им с целью правильной установки, обслуживания и безопасности при работе с оборудованием.

- Мощность: это устройство потребляет не менее 13 А. Большинство бытовых электросетей имеют мощность 13-16 А. Если сработал автоматический предохранитель цепи, убедитесь, что никакая другая техника или источник высокой нагрузки не подключены к той же цепи, что и гидромассажная ванна. Не используйте удлинители. Размотайте кабель питания перед использованием. Никогда не размещайте вилку на воспламеняющихся материалах.
- Нагревание воды. Этот нагревательный прибор при правильной настройке и использовании будет повышать температуру воды на 2 °C в час при условии, что крышка гидромассажной ванны установлена правильно. В зависимости от начальной температуры воды в гидромассажной ванне и внешней температуры воздуха может потребоваться некоторое время для нагрева воды до нужной температуры. Если начальная температура водопроводной воды 22 °C и вы хотите повысить ее на 16 °C до 38 °C, то время нагрева будет составлять: 16 °C/2 °C в час = 8 часов. При последующем использовании время нагрева можно сократить, поддерживая постоянную температуру в гидромассажной ванне (см. раздел «ПОДОГРЕВ И ТЕМПЕРАТУРА ВОДЫ»). Всегда закрывайте гидромассажную ванну, когда не используете ее.
- УЗО: данный продукт оснащен устройством защитного отключения (УЗО), расположенным на конце сетевого кабеля. УЗО необходимо проверять перед каждым использованием. НЕ используйте гидромассажную ванну, если УЗО не работает надлежащим образом. Инструкции по проверке работоспособности УЗО см. в руководстве по эксплуатации.
- Картридж фильтра: Дезинфицируйте воду в гидромассажной ванне должным образом, чтобы продлить срок службы картриджа. Подробную информацию о химическом составе и балансе воды в гидромассажной ванне см. в руководстве пользователя.

УСТАНОВКА СПА-ОБОРУДОВАНИЯ:

- При установке надувной спа-ванны вы можете заметить запах материала, который является нормальным для нового продукта, извлеченного из упаковки. Поэтому рекомендуется надуть ванну и оставить ее на открытом воздухе в течение дня для проветривания и устранения запаха, перед заполнением ее водой.
- Расстелите входящую в набор подстилку на свободном участке земли пузырьками вниз в месте, где вы хотели бы устроить спа.
- Для надувания ванны найдите пружинный клапан на ванне и спускное отверстие на блоке управления для обеспечения быстрого и правильного наполнения воздухом.

Советы по настройке механизма надувания:

- Широкий конец шланга для надувания вставляется в выходное отверстие сзади на блоке управления (чертежи и дополнительную информацию см. в Руководстве по эксплуатации).
- Чтобы прикрепить шланг для накачки воздуха к воздуховыпускному отверстию, откиньте боковую крышку основного блока управления для доступа к соответствующему отверстию. Вытяните защелку, чтобы открыть крышку, вставьте адаптер шланга со шлангом и снова закройте защелку на адаптере шланга, чтобы закрепить его на месте.
- После завершения накачки откройте защелку, извлеките шланг и снова закрепите защелку на выходном отверстии.

ПРИМЕЧАНИЕ: Чтобы избежать чрезмерного внутреннего давления, во время наполнения воздухом часть его пузырьками выходит через отверстие базы управления на дне. Это нормально.

Советы по настройке пружинного клапана:

- после снятия крышки клапана обратите внимание на пружинный штифт в центре клапана. Для закачки воздуха пружинный штифт должен находиться в верхнем / поднятом положении (закрытое положение клапана), при этом давление воздуха в насосе будет проталкивать воздух через клапан во время накачивания. Перед началом закачки проверьте стержень клапана и убедитесь, что он находится в верхнем / поднятом положении.
- Стержень можно вдавить и зафиксировать в таком положении, нажав на него пальцем и повернув его на 90 ° по часовой стрелке (открытое положение клапана), что позволит воздуху свободно выходить при сдувании.

СОХРАНЯЙТЕ ДАННУЮ ИНСТРУКЦИЮ

- Для правильного закрепления впускного сопла шланга (меньший конец шланга) нажмите на него, вдавив его в клапан, и поверните его по часовой стрелке до достижения фиксированного положения (до щелчка). Для снятия сопла после закачки воздуха поверните его против часовой стрелки и вытащите из клапана.
- После правильного заполнения спа-ванны воздухом необходимо закрыть крышку клапана для обеспечения надлежащей герметичности.

ОТОПЛЕНИЕ И ТЕМПЕРАТУРЫ ВОДЫ:

- Заполнение с функцией подогрева воды: Вы можете подогревать воду одновременно с заполнением ванны, что позволит сократить исходное время разогрева. Однако, убедитесь в том, что не используется вода с температурой, превышающей нормальную рабочую температуру спа (40 ° C). Температура воды выше 40 ° C приводит к отключению нагревательного блока и не считается безопасной. Всегда проверяйте температуру воды в спа перед использованием; для получения подробной информации по безопасному использованию см. руководство пользователя.
- Поддержание температуры воды: Ваше оборудование PureSpa работает, как любой бытовой прибор или устанавливаемый спа-центр; при постоянном использовании вы можете выбрать определенную температуру, поддерживаемую в спа, когда оборудование непосредственно не используется. Это позволит сократить время разогрева, когда вы захотите воспользоваться оборудованием. Например, поддержание температуры воды 30 ° C позволит достичь 38 ° C примерно за 4 часа. Помните, что увеличение температуры воды составляет около 2 ° C за час нагрева (скорость нагрева может меняться в зависимости от температуры наружного воздуха и других условий), поэтому рекомендуется планировать использование спа соответствующим образом.
ПРИМЕЧАНИЕ: У спа есть функция блокировки, которая отключает нагревательный элемент через 72 часа непрерывного нагрева, если заданная температура в течение этого периода не достигается. Это может происходить в условиях низкой температуры, что может мешать достижению заданной температуры. В этом случае нагревательный элемент спа отключится с отображением сообщения "END"; для возобновления работы нагревательного элемента потребуются нажатие кнопки установки температуры и повторная установка температуры. Попробуйте получить более низкую температуру, достижимую в данных условиях, которая не потребует повторного запуска нагревательного элемента через 72 часа.
- Температура воды во время использования: при использовании спа температура воды будет естественным образом понижаться с течением времени. Ожидаемое понижение температуры составляет от 1 ° C до 2 ° C в час в зависимости от внешних условий. Пока нагревательный элемент включается при заданной температуре, он начинает нагревать воду автоматически при снижении температуры воды на 1-2 ° C от заданной температуры. Пример: Если установленная температура 39 ° C, нагреватель не запускается, пока температура не упадет до 37 ° C. Если необходимо нагреть воду более быстро, можно выполнить повторную настройку нагревателя, выключив его и снова включив для начала нагрева воды до нужной температуры.

КРЫШКА ДЛЯ СПА-ВАННЫ:

- Крышка является важным компонентом спа, поскольку имеет решающее значение для нагрева воды и поддержания температуры, когда спа не используется. Кроме того, крышка является одним из важнейших элементов безопасности для предотвращения неразрешенного доступа к спа, особенно детям.
- Обратите внимание, что прилагаемые к крышке пряжки являются фиксирующими элементами. В полиэтиленовый пакет с руководством и другими принадлежностями также вложены 2 ключа. Каждая пряжка маркирована надписями "locked" (заблокировано) и "unlocked" (разблокировано) в целях удобства эксплуатации: вставьте ключ в отверстие на пряжке и поверните его в соответствующее положение блокировки или разблокировки.
- Для обеспечения безопасности от неразрешенного доступа, необходимо всегда ставить на ванну крышку, когда спа не используется, и заблокировать все пряжки. Храните ключи в недоступном для детей месте.
- В случае утери ключей для блокировки или разблокировки пряжек можно использовать плоскую отвертку сходного размера.

Дата изготовления: дата указана на изделии или упаковке.
Срок службы: Производителем не определен. Сделано в Китае.



СОХРАНЯЙТЕ ДАННУЮ ИНСТРУКЦИЮ

使用前请先阅读本安装指南

注意：快速安装指南手册提供了一些非常重要且有用的信息，但是并没有完全谈及所有安装方面的情况，我们始终建议您阅读理解并按照说明书进行正确的组装，保养及安全使用本产品。

- **电源：**本产品对插座及其支持电网的最低荷载要求为 13 安培。大部分家庭电路荷载是 13 至 16 安培。如果过载保护器或产品 RCD 跳脱，请检查是否有大功率电器设备与 SPA 共用同一线路。请勿使用延长线。使用前，解开电源线。请勿将插头放在易燃物之上。
- **加热：**盖上 SPA 的水池盖子后，请妥善设置好加热器，正常情况下水温每小时能上升两度。SPA 池内的原始水温以及环境温度会影响加热的时间。如果 SPA 池内的原始温度为 22 度，您想将其上升 16 度到 38 度，那么所需的加热时间为 $16^{\circ}\text{C}/2^{\circ}\text{C}$ 每小时 = 8 小时。如果是持续使用 SPA，可以通过设定恒温来缩短加热时间（详见之后的加热功能和水温化段落）。当没有使用 SPA 时，请确保 SPA 的水池盖子是盖上的。
- **漏电保护器：**本产品在电源线末端配有一个漏电保护器。每次使用本产品时需要先测试漏电保护器。当漏电保护器不能工作时请不要使用本产品。（详见产品说明书的漏电保护器测试指南）
- **滤芯：**对 SPA 的池水进行适当消毒可延长滤芯使用寿命。具体详见产品说明书中关于如何恰当使用化学药品的相关信息。

如何展开充气 SPA:

- 首次摊开产品时，您可能会闻到一股塑胶味，对新产品来说，这是正常的。建议您充气灌水前，先将产品搁置在室外一天将气味散发掉。
- 将底垫上带有泡泡孔的面朝下且铺平在您所挑选架设产品的干净整洁场地。
- 产品充气时，您要熟知是将充气管分别连接到 SPA 池外侧底端的充气阀和控制箱的排气口进行快速正确充气。

充气小提示：

- 充气管口较大的一段连接到控制箱后面的排气口（具体参考说明书图示及其他更多细节）。
- 将充气管连接到控制箱之前，先掀开控制箱侧盖露出鼓风机充气出风口。拉出门锁，打开盖子，插入软管接头与软管，然后将门锁重新关合，从而将软管接头固定到位。
- 充饱后，松开门锁，拔出充气管，再将门锁固定回原处。
注意：为了避免过度充气，在充气过程中会有一些空气从 SPA 控制箱中鼓泡口漏出。这是很正常的。

充气阀使用小技巧：

- 旋开 SPA 池底端的充气阀盖，注意阀门中的弹簧销是位于中心位置。充气时，弹簧销应该是处于向上弹起的状态（阀门是处于关闭状态），由于鼓泡机内部的气压会推动气体穿过阀门。充气前，检查阀门中间有弹簧销且向上突起状态。
- 弹簧销突起轴是可以向下按压且可以固定住，您可以用手向下按压且顺时针旋转 90° 。这样做的话是打开阀门便于气体排出，适用于排气。

保存此说明书

- 正确的连接充气管管口较小的一端。将管口插入充气阀门内，按顺时针方向转动中间突起轴直到完全固定住（您可能会听到喀哒声）。反方向逆时针转动可将充气管拔出。
- 一旦产品充饱后，请务必旋紧气嘴盖子，以免漏气。

加热功能和水温变化：

- 往池水内添加热水：您可以使用添加热水的方式缩短加热的时间。但是，请务必确保热水的温度不能超过产品正常允许的水温 40°C。一旦水温超过 40°C，加热功能将自动停止运行同时也是不安全的。产品使用前，请先测量水温且参照说明书了解更多关于安全使用的注意事项。
- 如何保持水温：本产品就好比一件家用电器或者固定的温泉缸，产品不用时，您可以设定一定的温度进行维持水温方便持续使用，同时也可以缩短加热时间。例如，维持水温在加热大约 4 个小时后从 30°C 上升到 38°C。记住一点，水温平均每小时大约上升 2°C（这有可能随着室外温度和环境而变），所以开始您的 SPA 使用计划吧。
注意：本产品带有安全自动保护功能即加热持续 72 小时后水温仍然没变化的话，加热功能会自动停止运行。这可能发生在室外较冷的情况下导致设定的水温无法达到。这种情况下，加热功能会自动停止运行且显示代码“END”，此时您需要重新设定温度进行重新加热。您可以先设定相对较低的水温，这样的话，产品就不需要待机 72 小时后才会加热。
- 水温变化：当您使用 SPA 时，水温经过一段时间将稍微下降。根据外部环境的情况水温大约每小时下降 1°C~2°C，但是只要加热系统有在运行，当水温低于设定温度 1~2°C 时，加热系统会自动启动，进行加热。
例如：如果您设定的水温是 39°C，当水温下降时，加热系统是不会马上开始加热，除非水温已经下降到 37°C。如果您想让它快一点开始加热，您可以简单断开电源并重启后，再次设定理想温度。

充气盖子：

- 产品不用时，充气盖子是加热和维持水温过程中一个非常重要的配件。同时可以有效防止小孩在无人看护的情况下进入池内。
- 注意充气盖子上的扣子是可以和 SPA 扣在一起的。提供的两把锁匙与说明书和其他配件包装在一起。每个扣子都有“加锁”和“解锁”两个图标。插入锁匙转动到相应的图标位置即可进行加锁和解锁。
- 产品不使用时，请您始终盖上充气盖，扣上扣子并锁紧以确保人员安全。同时将钥匙放在小孩接触不到的地方。
- 如果不慎遗失钥匙，您可以使用大小相仿的一字螺丝刀进行加解锁。

©2024 Intex Marketing Ltd. - Intex Development Co. Ltd. - Intex Recreation Corp. All rights reserved/Tous droits réservés/Todos los derechos reservados/Alle Rechte vorbehalten. Printed in China/Imprimé en Chine/Impreso en China/Gedruckt in China.

®™ Trademarks used in some countries of the world under license from/®™ Marques utilisées dans certains pays sous licence de/Marcas registradas utilizadas en algunos países del mundo bajo licencia de/Warenzeichen verwendet in einigen Ländern der Welt in Lizenz von/Intex Marketing Ltd. to/à/a/an Intex Development Co. Ltd., Hong Kong & Intex Recreation Corp., P.O. Box 1440, Long Beach, CA 90801 • Distributed in the European Union by/Distribué dans l'Union Européenne par/Distribuido en la unión Europea por/Vertrieb in der Europäischen Union durch/Intex Trading B.V., Ettenseweg 46, 4706 PB Roosendaal – The Netherlands • Distributed in the UK by Unitex Service (UK) Limited, 21 Holborn Viaduct, London EC1A 2DY, UK.
www.intexcorp.com

INTEX®

保存此说明书